

A-C CONTROL CIRCUIT

D-C CONTROL CIRCUIT

SIMPLIFIED CONTROL CIRCUIT SCHEMATIC

SCHEMATIC DIAGRAM
TAPE TRANSPORT
CONTROL CIRCUITS

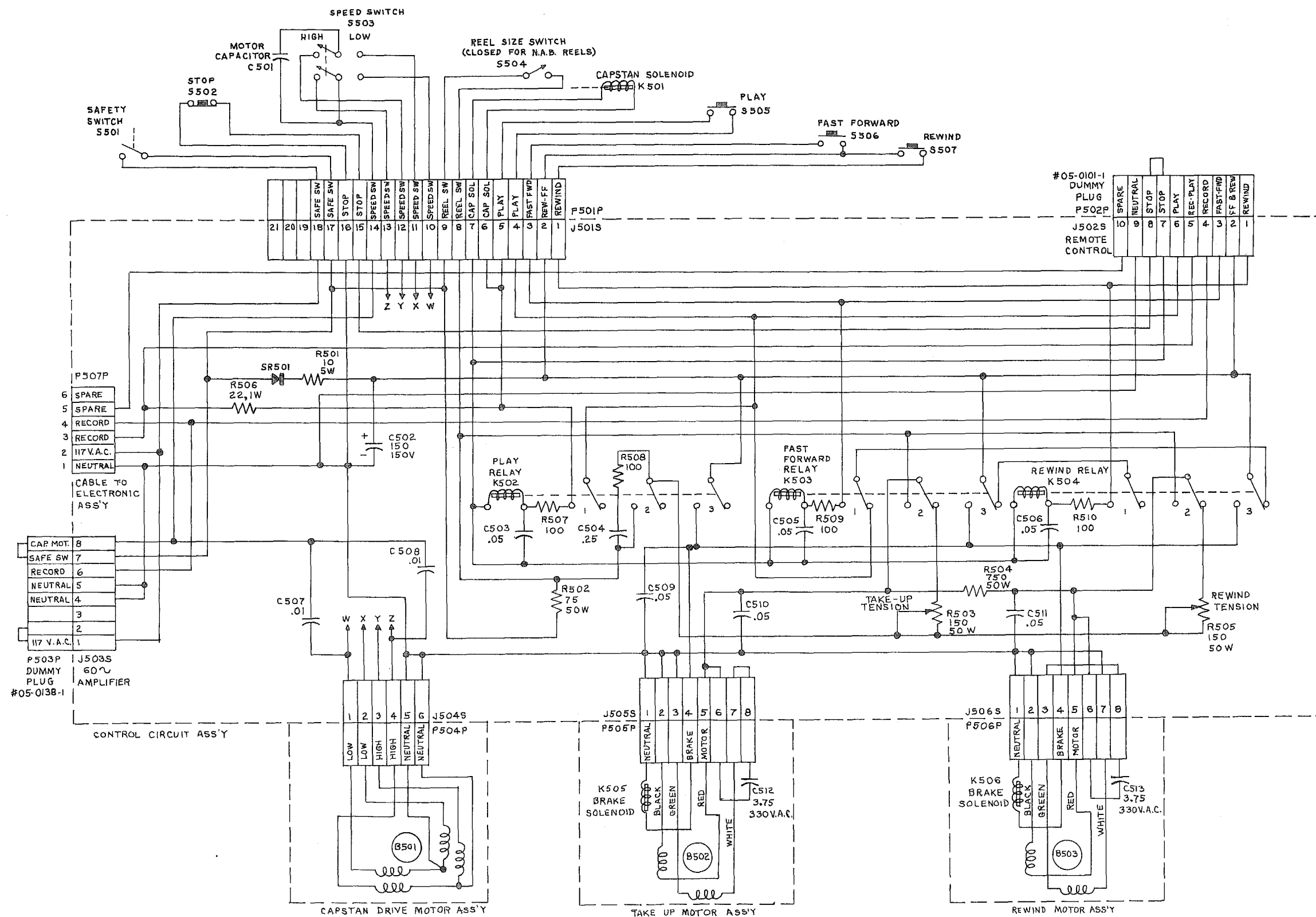

NOTES:
1. ALL RESISTORS IN OHMS & RATED 1/2 WATT UNLESS OTHERWISE SPECIFIED
2. ALL CAPACITORS IN MICROFARADS AND RATED 400V UNLESS OTHERWISE SPECIFIED

3 3/4 ips (120 μ sec)

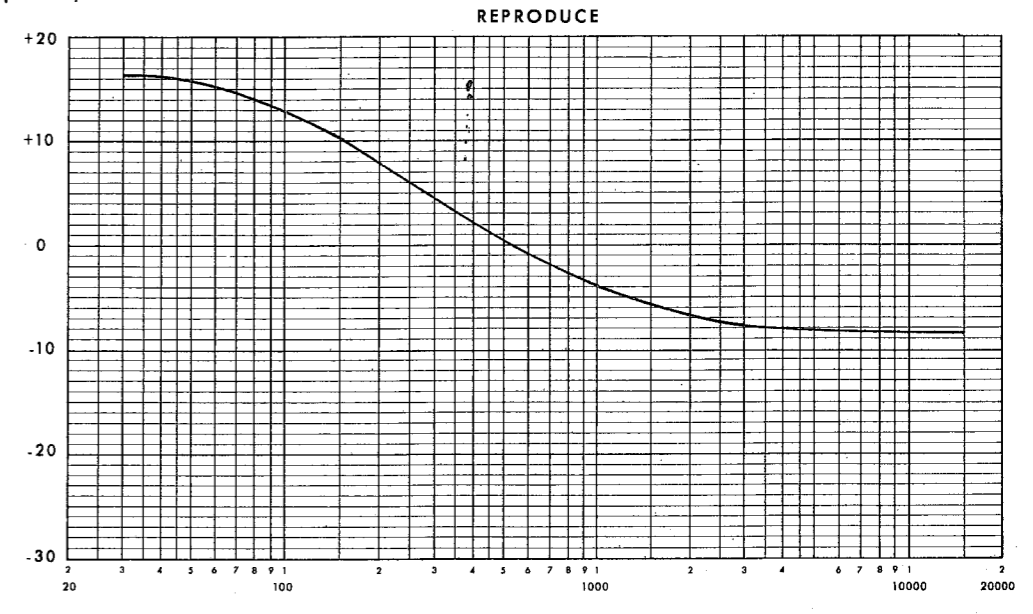
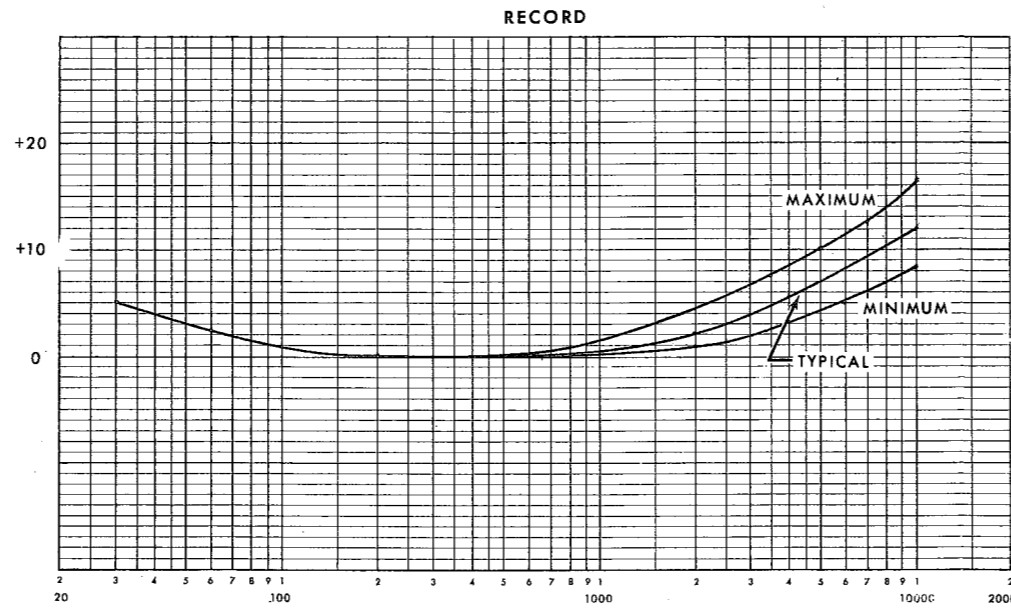

7 1/2 ips NAB

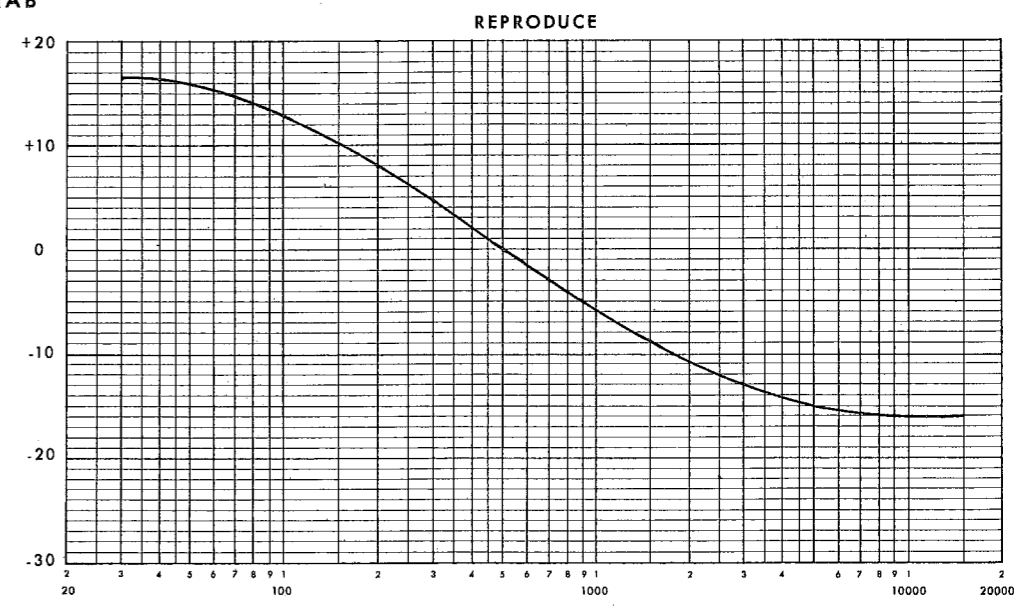
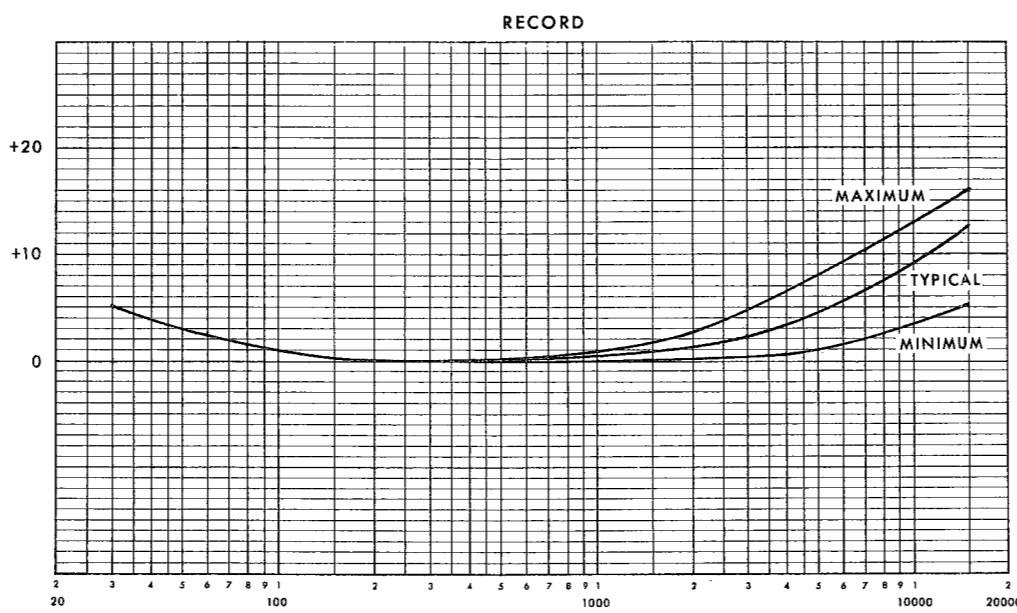

15 ips NAB

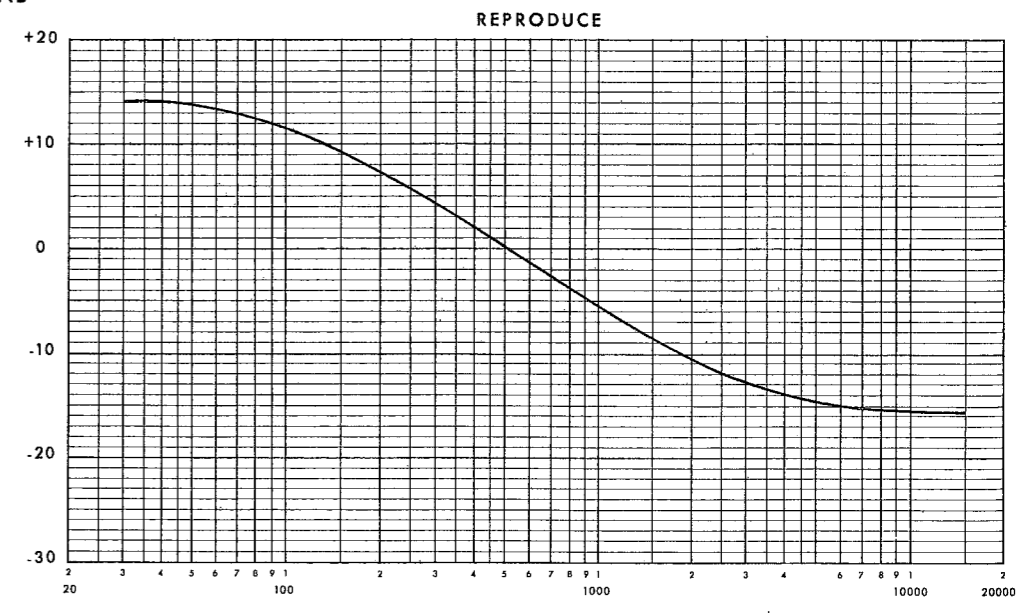
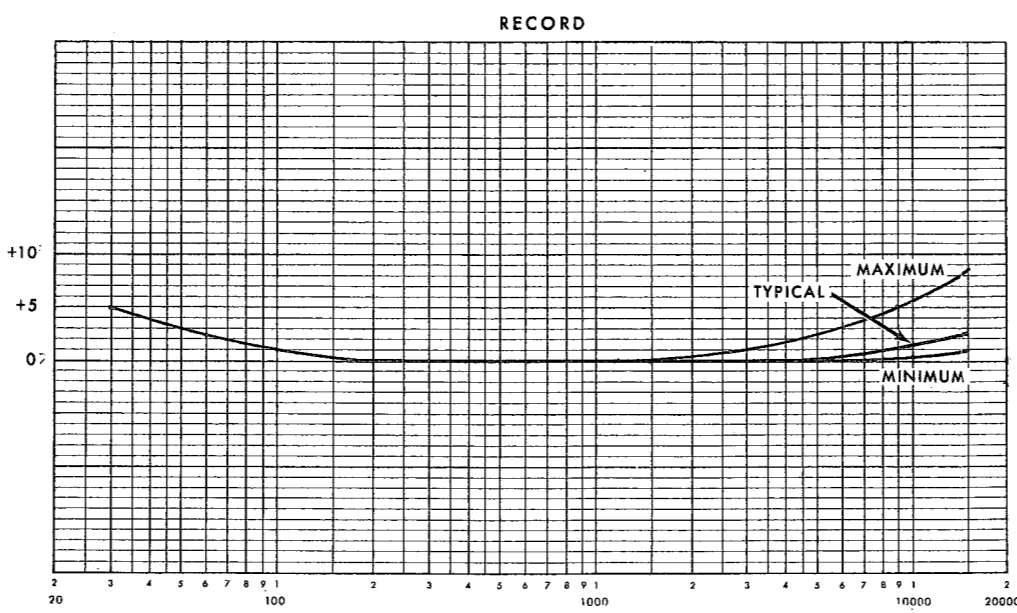

NOTE 1
RECORD CURVES SHOWN ARE
APPROXIMATE AND WILL VARY
WITH TAPE TO MAINTAIN FLAT
OVERALL RESPONSE.

APPLICABLE RESPONSE
CURVES

