

Calibration Notes:

Catalog No. 4890407-01
Issued: March 1977

~~1.1~~
~~3.0~~

~~1.1~~ ~~2.0~~

AES Equalization

30 IPS	+ .4 db	80 Hz
	Flat	70 Hz
	- .6 db	52 Hz
	Flat	33 Hz
	- .5 db	25 Hz
	- 1.3 db	20 Hz

ATR-100 SERIES RECORDER/REPRODUCER

Low end, two rotations ccw
from reference

IE - Equalization		
15 IPS	+ .3 db	160 Hz
	Flat (+ .05)	100 Hz
	Flat	85 Hz
	+ .3 db	40 Hz

OPERATION AND MAINTENANCE

AMPEX CORPORATION
AUDIO-VIDEO SYSTEMS DIVISION

LIST OF EFFECTIVE PAGES

CATALOG NO. 4890407-01

Issued: March 1977

Pages	Dash No.	Pages	Dash No.
Title	-01	6-59/60	-01
A	-01	6-61 and 6-62	-01
i through xiv	-01	6-64/64	-01
1-0 through 1-17/18.	-01	6-65/66	-01
2-1 through 2-32	-01	6-67 and 6-68	-01
3-1 through 3-16	-01	6-69/70	-01
4-1 through 4-64	-01	6-71 and 6-72	-01
5-1 through 5-81/82.	-01	6-73/74	-01
5-83 through 5-95/96	-01	6-75/76	-01
6-i through 6-vii/viii	-01	6-77 and 6-78	-01
6-1 through 6-3/4.	-01	6-79/80	-01
6-5 through 6-19/20.	-01	6-81 and 6-82	-01
6-21 /22	-01	6-83/84	-01
6-23 through 6-30	-01	6-85/86	-01
6-31/32	-01	6-87 and 6-88	-01
6-33/34	-01	6-89 through 6-93/94	-01
6-35 through 6-43/44	-01	6-95/96	-01
6-45 and 6-46	-01	6-97 through 6-99/100.	-01
6-47/48	-01	6-101 through 6-105/106.	-01
6-49 and 6-50	-01	6-107/108	-01
6-51/52	-01	6-109/110	-01
6-53 and 6-54	-01	6-111/112	-01
6-55/56	-01	6-113/114	-01
6-57/58	-01	6-115 through 6-124	-01

Prepared By

AVSD TECHNICAL PUBLICATIONS

AMPEX CORPORATION 401 Broadway Redwood City, California 94063

TABLE OF CONTENTS

SECTION NO.	TITLE	PAGE NO.
1	GENERAL INFORMATION	1-1
	1-1. DESCRIPTION	1-1
	1-2. Tape Transport	1-1
	1-3. Head Assembly	1-4
	1-4. Control Unit	1-5
	1-5. Electronics Assembly	1-6
	1-6. Power Supply	1-8
	1-7. EQUIPMENT CONFIGURATIONS	1-8
	1-8. ACCESSORIES	1-9
	1-9. Input/Output Module and Mainframe	1-9
	1-10. Remote Control Unit	1-12
	1-11. SPECIFICATIONS	1-12
2	INSTALLATION	2-1
	2-1. UNPACKING AND INSPECTION	2-1
	2-2. INSTALLATION SITE	2-1
	2-3. MOUNTING THE RECORDER/REPRODUCER	2-1
	2-4. Cabinet Mount	2-1
	2-5. Cabinet Mounted on a Pedestal	2-3
	2-6. Fixed-Rack Mount	2-6
	2-7. Slide Rack Mount	2-6
	2-8. MOUNTING THE INPUT/OUTPUT MODULE ACCESSORY	2-8
	2-9. Cabinet Mount	2-11
	2-10. Rack Mount	2-11
	2-11. CHECKING CABLES AND COMPONENTS	2-11
	2-12. CONNECTING AC POWER	2-11
	2-13. AUDIO SIGNAL CONNECTIONS	2-13
	2-14. Recorder/Reproducer Input/Output Connectors	2-13
	2-15. Input-Connector Wiring	2-15
	2-16. Output-Connector Wiring	2-15
	2-17. Input/Output Assembly Connectors	2-15
	2-18. Input-Connector Wiring	2-15
	2-19. Output-Connector Wiring	2-16
	2-20. REMOTE CONTROL UNIT INSTALLATION	2-19
	2-21. INITIAL ADJUSTMENTS	2-19
	2-22. Turntable Positioning for Reel Size	2-19
	2-23. Control Unit Relocation	2-21

TABLE OF CONTENTS (Continued)

SECTION NO.	TITLE	PAGE NO.
2	INSTALLATION (Continued)	
	2-24. Spool-Speed Selection	2-23
	2-25. Play/Edit Mode Lockout	2-23
	2-26. Record Mode Lockout	2-24
	2-27. Tape Timer Display Selection	2-24
	2-28. Minutes, Seconds, and Tenths of Seconds Display	2-24
	2-29. Hours, Minutes, and Seconds Display	2-25
	2-30. PURC Operation Selection	2-26
	2-31. INITIAL CHECKOUT PROCEDURE	2-29
	2-32. FACTORY SHIPPED OPERATIONAL CONFIGURATION	2-31
	2-33. CHECKING OPERATING LEVEL	2-31
3	OPERATION	3-1
	3-1. CONTROLS AND INDICATORS	3-1
	3-2. PRE-OPERATING PROCEDURES	3-1
	3-3. OPERATING PROCEDURES	3-11
	3-4. Recording	3-11
	3-5. Fast Winding	3-13
	3-6. Reproducing	3-13
	3-7. Tape Timer Operation	3-13
	3-8. Sel-Sync Function	3-13
	3-9. Editing	3-14
	3-10. Spooling	3-14
	3-11. Remote Control Operation	3-15
	3-12. PURC Operation	3-15
	3-13. Editing Procedures	3-15
	3-14. Insert Edit	3-16
4	THEORY OF OPERATION.	4-1
	4-1. FUNCTIONAL DESCRIPTION OF TAPE TRANSPORT	4-1
	4-2. BLOCK DIAGRAM FUNCTIONAL DESCRIPTION	4-1
	4-3. Thread Mode	4-2
	4-4. Reproduce Mode	4-2
	4-5. Record Mode	4-2
	4-6. Spool Mode	4-2

TABLE OF CONTENTS (Continued)

SECTION NO.	TITLE	PAGE NO.
4	THEORY OF OPERATION (Continued)	
4-7.	Shuttle Modes	4-2
4-8.	Control Unit	4-2
4-9.	DETAILED THEORY OF OPERATION	4-4
4-10.	Capstan Servo Functional Description	4-5
4-11.	Capstan Servo Circuit Details	4-6
4-12.	Capstan Tach Assembly	4-6
4-13.	Phase Comparator	4-6
4-14.	Speed Reference Frequency	4-6
4-15.	Direction Logic and MDA Driver	4-9
4-16.	Capstan Motor Edit Offset	4-9
4-17.	Play Mode	4-9
	4-18. Underspeed Condition	4-9
	4-19. Phase Lock	4-9
4-20.	Spool Mode	4-10
4-21.	Stop Mode	4-10
4-22.	Reel Servo Functional Description	4-10
4-23.	Reel Servo Circuit Details	4-10
4-24.	Takeup and Supply Tension Sensors	4-10
4-25.	Compensation Amplifier	4-12
4-26.	Pulse-Width Modulator	4-12
4-27.	Output Gates and MDA	4-12
4-28.	Tension Arm Limit Detector	4-14
4-29.	Tension Logic	4-15
4-30.	Velocity/Acceleration Control	4-16
4-31.	Edit Offset Command	4-16
4-32.	Dynamic Emergency Braking	4-16
4-33.	Transport Control PWA No. 7	4-16
4-34.	System Wakeup Circuit	4-18
4-35.	Control Circuit Operation	4-18
	4-36. Rewind and Fast Forward Mode	4-18
	4-37. Spool Mode	4-18
	4-38. Tape Lifter Operation	4-18
	4-39. Play Mode	4-22
	4-40. Record Mode	4-22
	4-41. Stop Record Mode	4-23
	4-42. Thread Mode	4-23
	4-43. Unthread (Stop/Edit) Mode	4-23
	4-44. Edit Modes	4-23

TABLE OF CONTENTS (Continued)

SECTION NO.	TITLE	PAGE NO.
4	THEORY OF OPERATION (Continued)	
4-45.	Tension Arm Limit Detectors	4-23
4-46.	Audio Control PWA No. 5	4-24
4-47.	Signal Mode Selection	4-24
4-48.	Latches	4-24
4-53.	Safe Mode	4-25
4-54.	Ready Mode	4-26
4-55.	Record Mode	4-26
4-56.	Reproduce Mode	4-28
4-57.	Sync Mode	4-28
4-58.	Input Mode	4-28
4-59.	Wakeup Line	4-29
4-60.	Illegal Speed	4-29
4-61.	Multiplexer System	4-29
4-62.	Master Oscillator and Counters	4-30
4-63.	Master Erase Bus	4-34
4-64.	Master Bias Bus	4-35
4-65.	Two-Speed Operation	4-35
4-66.	Four-Speed Operation	4-35
4-67.	Illegal Speed Detector	4-35
4-68.	Main Audio Functional Description	4-36
4-69.	Main Audio Circuit Details	4-39
4-70.	Control Logic	4-39
4-71.	Speed Decode Logic	4-39
4-72.	Erase Ramping	4-39
4-73.	Record Ramping and PURC Logic	4-40
4-74.	Record Circuits	4-44
4-75.	Erase Circuit	4-46
4-76.	Reproduce Circuits	4-48
4-77.	Audio Output Circuit	4-50
4-78.	Input/Output Assembly (Accessory)	4-50
4-79.	Line Input Amplifier	4-51
4-80.	Input Signal Monitoring	4-51
4-81.	Reproduce Mode	4-52
4-82.	Meter Circuit Operation	4-52
4-83.	Erase and Bias Voltage Confidence Indicators	4-52
4-84.	± 15 -Vdc Regulator	4-54
4-85.	Tape Timer Functional Description	4-54
4-86.	Tape Timer Circuit Details	4-54

TABLE OF CONTENTS (Continued)

SECTION NO.	TITLE	PAGE NO.
4	THEORY OF OPERATION (Continued)	
	4-87. Tape Timer Display	4-54
	4-88. Tape Timer Tachometer	4-56
	4-89. Tape Timer Arithmetic Logic	4-56
	4-90. Initialization	4-57
	4-91. Count-Up Mode	4-57
	4-92. Count-Down Mode	4-59
	4-93. Tape Run Out	4-61
	4-94. Power Supply Functional Description	4-61
	4-95. Power Supply Circuit Details	4-61
	4-96. AC Supply	4-61
	4-97. 20-Volt Servo Supply	4-61
	4-98. 20-Volt Electronically Filtered Supply	4-61
	4-99. 5-Vdc Regulated Supply	4-62
5	MAINTENANCE	5-1
	5-1. GENERAL	5-1
	5-2. OVERALL TEST EQUIPMENT REQUIREMENTS	5-1
	5-3. PREVENTIVE MAINTENANCE	5-3
	5-4. Cleaning	5-3
	5-5. Tape Patch Cleaning	5-3
	5-6. Optical Devices	5-4
	5-7. Demagnetizing	5-4
	5-8. Scrape Flutter Idler	5-4
	5-9. Lubrication	5-6
	5-10. Head Gate Support Busing	5-6
	5-11. Tape Lifter Arm Bushings	5-6
	5-12. CONVERSION	5-7
	5-13. Changing Channel Configuration	5-7
	5-14. Changing Tape Width	5-8
	5-15. Changing Operating-Speed Pair and Master Bias Operation	5-8
	5-16. Two-Speed Dual Master Bias	5-10
	5-17. Four-Speed Master Bias	5-10
	5-18. Changing Input/Output Assembly Operating Configuration	5-11
	5-19. Input Amplifier	5-11
	5-20. Increasing Input Sensitivity	5-11

TABLE OF CONTENTS (Continued)

SECTION NO.	TITLE	PAGE NO.
5	MAINTENANCE (Continued)	
	5-21. Balanced or Unbalanced Input	5-12
	5-22. Bypassing Input Transformer	5-12
	5-23. Shield Grounding.	5-13
5-24.	Output Amplifier.	5-13
	5-25. Balanced or Unbalanced Output	5-13
	5-26. Bypassing Output Transformer	5-13
	5-27. Increasing Output Resistance with Balanced Output	5-13
	5-28. Shield Grounding.	5-13
5-29.	ALIGNMENT AND ADJUSTMENTS	5-13
5-30.	Audio Signal System Alignment	5-13
5-31.	Use of Alignment Tapes — General Discussion.	5-14
5-32.	Using a Flux Loop — General Discussion	5-17
5-33.	Head Azimuth and Phase — General Discussion	5-18
5-34.	Operating Level — General Discussion	5-20
5-35.	Reproduce Equalization Adjustment	5-21
	5-36. Equalization Adjustment Using an Alignment Tape.	5-21
	5-37. Reproduce Equalization Adjustment Using a Flux Loop	5-25
5-38.	Reproduce Head Azimuth and Phase Adjustment	5-26
	5-39. 2-Track or 4-Track Reproduce Head Azimuth and Phase Adjustment	5-26
	5-40. Full Track Reproduce Head Azimuth Adjustment	5-27
5-41.	Operating Level Adjustment	5-27
	5-42. 370 nWb/m Operating Level Adjustment.	5-28
	5-43. 260 nWb/m Operating Level Adjustment.	5-28
	5-44. 185 nWb/m Operating Level Adjustment.	5-29
5-45.	Record Alignment	5-29
	5-46. First Speed Record Alignment.	5-30
	5-47. Second Speed Record Alignment.	5-34
	5-48. 2-Track or 4-Track Record Head Azimuth and Phase Adjustment	5-36
	5-49. Full-Track Record Head Azimuth Adjustment.	5-37
5-50.	Sel Sync Equalization and Gain Adjustment	5-38
5-51.	Erase Depth Adjustment and Measurement	5-39
5-52.	Input/Output Assembly Adjustment	5-40

TABLE OF CONTENTS (Continued)

SECTION NO.	TITLE	PAGE NO.
5	MAINTENANCE (Continued)	
	5-53. Offset Null Adjustments	5-40
	5-54. Record Level Adjustment (Method 1)	5-43
	5-55. Reproduce Level Adjustment (Method 1)	5-43
	5-56. Record and Reproduce Level Adjustment (Method 2)	5-43
	5-57. PURC Timing Alignment	5-44
	5-58. Tape Transport Adjustments	5-46
	5-59. Capstan Tach Sensor	5-46
	5-60. Tension Arm Limits.	5-50
	5-61. Tape Tension	5-50
	5-62. Tape Lifters.	5-52
	5-63. Tape Lifter Solenoid	5-53
	5-64. Tape Lifter Arms.	5-53
	5-65. Head Gate	5-55
	5-66. Head Gate Height in Latched Position	5-56
	5-67. Head Gate Shield Alignment with Head Assembly Shield	5-57
	5-68. Head Gate Catch	5-57
	5-69. Head Gate Vertical Alignment	5-59
	5-70. Tape Peeler	5-59
	5-71. PERFORMANCE TESTS.	5-60
	5-72. Tape Tension	5-60
	5-73. Absolute Tape-Speed Accuracy	5-60
	5-74. Speed Variation	5-61
	5-75. Operating Level	5-62
	5-76. Signal-to-Noise Ratio	5-62
	5-77. Harmonic Distortion	5-64
	5-78. SMPTE Intermodulation Distortion.	5-68
	5-79. Flutter	5-68
	5-80. CORRECTIVE MAINTENANCE.	5-69
	5-81. Head Maintenance	5-70
	5-82. Changing Head Assembly	5-70
	5-83. Changing Head Stacks	5-71
	5-84. Troubleshooting	5-72
	5-85. Extender Boards	5-74
	5-86. Power Transistor Locations	5-74
	5-87. Flutter	5-75
	5-88. Troubleshooting Hints	5-75

TABLE OF CONTENTS (Continued)

SECTION NO.	TITLE	PAGE NO.
5	MAINTENANCE (Continued)	
5-89.	Component Replacement Procedures	5-87
5-90.	Power Supply	5-87
5-91.	Electronics Assembly	5-87
5-92.	Capstan/Tach Assembly	5-87
5-93.	Capstan Motor and Parts Replacement.	5-89
5-94.	Capstan Motor	5-90
5-95.	Capstan Motor Brushes	5-90
5-96.	Flywheel and Rotor.	5-91
5-97.	Capstan Shaft Assembly	5-92
5-98.	Capstan Shaft Bearings.	5-94
5-99.	Reel Drive Motors and Brush Replacement	5-94
5-100.	Reel Drive Motor Replacement	5-94
5-101.	Brush Replacement	5-94
6	PARTS LISTS AND SCHEMATICS.	6-i
	INDENTURED LISTS OF ASSEMBLIES	6-ii
	NUMERICAL LIST OF ASSEMBLIES	6-v
	NUMERICAL LIST OF SCHEMATICS	6-vii

LIST OF ILLUSTRATIONS

FIGURE NO.	TITLE	PAGE NO.
1-1	Recorder/Reproducer, Unmounted	1-2
1-2	Top View of Tape Transport with Front and Rear Overlay Panels and the Head Cover Removed	1-3
1-3	Head Assembly	1-4
1-4	Head Assembly with Head Shield Removed	1-5
1-5	Control Unit	1-6
1-6	Electronics Assembly, Cover Panel Removed	1-7
1-7	Power Supply	1-8
1-8	Power Supply Chassis with Cover Panel Removed	1-9
1-9	ATR-100 Series Mounting Configurations	1-10
1-10	Input/Output Assembly	1-11
2-1	Mounting Dimensions	2-2
2-2	Rear Overlay Panel, Six Mounting Screws	2-3
2-3	Cabinet and Fixed-Rack Mount Transport-Mounting Holes	2-4
2-4	Cabinet Mounted on a Pedestal	2-5
2-5	Pedestal Assembly, Exploded View	2-7
2-6	Fixed-Rack Mount with Electronics Assembly Cover Panel Removed	2-8
2-7	Slide Rack Mount Kit	2-9
2-8	Slide-Rack Mount Transport-Mounting Holes	2-10
2-9	Left Hand Slide, Top View	2-10
2-10	Input/Output Assembly Mounting	2-12
2-11	Recorder/Reproducer, Rear View	2-13
2-12	Main Power Jumper Location	2-14
2-13	Connector Locations, Bottom View of Recorder/Reproducer	2-16
2-14	Input/Output Assembly, Rear View.	2-17
2-15	Input/Output Assembly Connector Wiring	2-18
2-16	Supply Motor Mounting	2-20
2-17	Supply Turntable.	2-21
2-18	Rear View of Transport	2-22
2-19	Tape Transport	2-22
2-20	Rear View of Filler Panel (Transport Components Removed for Clarity)	2-23
2-21	Spool Speed Jumper, Capstan Servo PWA No. 8	2-24
2-22	Normal/Play Edit-Lockout Jumper, Transport Control PWA No. 7	2-25
2-23	Record Lockout Jumper J5, Audio Control PWA No. 5	2-26
2-24	Tape Timer Display Selection Jumpers, Transport Control PWA No. 7	2-27

LIST OF ILLUSTRATIONS (Continued)

FIGURE NO.	TITLE	PAGE NO.
2-25	Control Unit, Case Bottom Removed	2-27
2-26	Inside View of Control Unit.	2-28
2-27	Tape Timer Display Selection Jumper, Control Unit PWA No. 1	2-28
2-28	PURC Jumper, PADNET PWA.	2-29
3-1	Tape Threading Path	3-12
3-2	PURC On/Off Timing Relationships	3-16
4-1	ATR-100 System, Simplified Block Diagram	4-3
4-2	Capstan Servo General Simplified Block Diagram	4-5
4-3	Capstan Servo Simplified Block Diagram	4-7
4-4	Reel Servo General Simplified Block Diagram	4-11
4-5	Reel Servo Simplified Block Diagram	4-13
4-6	Pulse Width Modulator Waveforms, Takeup Reel Servo	4-14
4-7	Dead Zone Generator Operation and MDA Switch Transistor Conduction State.	4-15
4-8	Takeup Dynamic Brake, Simplified Schematic.	4-17
4-9	Transport Control PWA No. 7, Simplified Block Diagram	4-19
4-10	Signal Mode Selection, Interconnection Simplified Block Diagram	4-25
4-11	Channel 1 Signal-Mode Selection Simplified Block Diagram, Audio Control PWA No. 5	4-27
4-12	Multiplexer Simplified Interconnect Block Diagram, Audio Control PWA No. 5 and Control Unit	4-31
4-13	Multiplexer Simplified Block Diagram, Audio Control PWA No. 5	4-32
4-14	Master Oscillator and Counters, Simplified Block Diagram (PWA No. 5)	4-33
4-15	Master Erase Bus, Simplified Schematic Diagram, Audio Control PWA No. 5	4-34
4-16	Master Bias Bus, Two-Speed Simplified Schematic (PWA No. 5)	4-37
4-17	Main Audio Simplified Block Diagram	4-38
4-18	Main Audio Control Logic, Simplified Block Diagram	4-41
4-19	Record Ramping and PURC Delay Timing	4-42
4-20	Audio Record Circuits, Simplified Block Diagram	4-45
4-21	Erase Circuit, Simplified Block Diagram	4-47
4-22	Audio Reproduce Circuits, Simplified Block Diagram	4-49
4-23	Audio Output Circuit, Simplified Block Diagram.	4-51

LIST OF ILLUSTRATIONS (Continued)

FIGURE NO.	TITLE	PAGE NO.
4-24	Input/Output Assembly, Simplified Block Diagram	4-53
4-25	Tape Timer, Simplified Block Diagram	4-55
4-26	Count Up Logic, Simplified Block Diagram	4-58
4-27	Count Down Logic, Simplified Block Diagram	4-60
4-28	Power Supply Assembly, Simplified Block Diagram	4-63
5-1	Top View of Head Assembly, Head Shield Removed	5-5
5-2	Scrape Flutter Idler, Side Cross-Section View	5-6
5-3	Tape Guide Securing Screws	5-8
5-4	Overlay Panels, Audio Control PWA No. 5	5-9
5-5	Speed Selection Jumpers, PADNET PWA	5-10
5-6	Speed/Bias Selection Jumpers, Audio Control PWA No. 5	5-11
5-7	Input/Output Assembly Module – Jumper Terminals and Capacitor C20	5-12
5-8	Relative Fringing Frequency Response Due to Fringing Effect	5-15
5-9	Equalized Flux Loop Response for 15 in/s and 30 in/s	5-18
5-10	Reproduce Response From Unequalized Flux Loop	5-19
5-11	Azimuth Adjustment Screw Location	5-20
5-12	Main Audio PWA 1, 2, 3, or 4 – Alignment Controls	5-23
5-13	Record Equalization Standard Selector Switch S1, PANDET PWA	5-30
5-14	Audio Control PWA No. 5	5-31
5-15	I/O Level Set Accessory	5-41
5-16	Input/Output Module Adjustment Control Locations	5-41
5-17	Input/Output Module Assembly	5-42
5-18	Automatic Record/Play Cyclus	5-45
5-19	Capstan Tach Sensor Adjustment	5-47
5-20	TP3 and TP4 Waveforms, PWA No. 8	5-48
5-21	Front and Rear Tach, Cover Panel Removal	5-49
5-22	Head Cover and Overlay Panels	5-51
5-23	Tension Arm Limits Adjustment	5-51
5-24	Tape Tension Adjustment Controls, PWA No. 9	5-52
5-25	Measuring Tape Tension	5-53
5-26	Tape Lifter Solenoid Adjustment Screw, Right Side of Tape Transport	5-54
5-27	Tape Lifter Rollers and Solenoid, Rear View of Transport	5-55
5-28	Top View of Transport, Head Cover Removed	5-56
5-29	Head Gate in Latched (Down) Position	5-57

LIST OF ILLUSTRATIONS (Continued)

FIGURE NO.	TITLE	PAGE NO.
5-30	Head Gate in Latched (Down) Position, Front View of Transport	5-58
5-31	Head Gate in Unlatched (Up) Position.	5-58
5-32	Tape Peeler Adjustment	5-59
5-33	30-Hz to 18-kHz Band Limiting Filter	5-63
5-34	ANSI 'A' Weighted Filter	5-63
5-35	Universal Noise Filter Schematic	5-65
5-36	Head Assembly and Tape Guides	5-70
5-37	Top View of Transport with Head Assembly Removed	5-71
5-38	Top View of Head Assembly with Main Head Shield Removed	5-72
5-39	Head Assembly Spring Loaded Pin Locations, Main Head Shield Removed	5-73
5-40	Power Transistor Locations on Heatsink	5-74
5-41	No Reproduce Output – Troubleshooting Flow Chart	5-83
5-42	No System Output in Reproduce, Sel Sync, or Output Modes – Troubleshooting Flow Chart.	5-84
5-43	No Recording on Tape – Troubleshooting Flow Chart	5-85
5-44	No or Poor Erase – Troubleshooting Flow Chart.	5-86
5-45	Power Supply Removal	5-88
5-46	Exploded View of Capstan Motor	5-90
5-47	Capstan Motor Removal	5-91
5-48	Capstan Motor Rear Cover Assembly	5-92
5-49	Rear View of Capstan Motor Assembly	5-93
5-50	Reel Drive Motor Brush Replacement, Rear Side View of Transport	5-95

LIST OF TABLES

TABLE NO.	TITLE	PAGE NO.
1-1	Electronics Assembly Printed Wiring Assemblies	1-7
1-2	Optional Equipment	1-12
1-3	Accessory Equipment	1-12
1-4	Specifications	1-13
2-1	Power Jumper Positions	2-15
2-2	Connector J13 Channel/Signal Identification, Channels 1 and 2	2-17
2-3	Connector J14 Channel/Signal Identification, Channels 3 and 4	2-18
2-4	Factory Shipped Operational Configuration	2-32
3-1	Tape Transport Controls and Indicators	3-2
3-2	Recorder Control Panel, Transport Controls and Indicators.	3-3
3-3	Recorder Control Panel, Signal System Controls and Indicators.	3-7
3-4	Input/Output Module Accessory, Controls and Indicators	3-10
3-5	PURC Edit Delay Times	3-15
4-1	Command Signal Abbreviation.	4-4
4-2	Phase Comparator Output Logic States	4-8
4-3	Tape Speed Reference Frequencies	4-8
4-4	Capstan Servo FET Switch Control	4-9
4-5	Channel 1 Signal Mode Selection Output-Signal Logic States	4-28
4-6	Speed Jumper Placement and Bias Switch Setting, Audio Control PWA No. 5	4-38
4-7	Preset Equalization Network Settings	4-46
4-8	Counter Data Word Format	4-56
5-1	Overall Test and Maintenance Equipment Requirements	5-1
5-2	Lubricants Used on Recorder/Reproducer	5-7
5-3	Reproduce Frequency Response Tolerances	5-16
5-4	Amplitude Correction Factors for Setting Operating Level when using Full-Track Alignment Tapes on 2-Track or 4-Track Systems	5-16
5-5	Capacitor Values for Passive Equalization of High Frequency Turnover	5-18
5-6	Relative Operating Levels.	5-21
5-7	PADNET PWA – Alignment Controls	5-24

LIST OF TABLES (Continued)

TABLE NO.	TITLE	PAGE NO.
5-8	Record Equalization Standard	
	Selector Switch S1 Switch Positions (PADNET PWA)	5-30
5-9	Audio Control PWA No. 5 — Four-Speed Alignment Controls.	5-32
5-10	Audio Control PWA No. 5 — Two-Speed Alignment Controls .	5-33
5-11	Recommended Frequency, Signal Level, and Overbias Values for Bias and Equalization Adjustment . .	5-34
5-12	Overall Record/Reproduce Frequency Response	5-35
5-13	Overall Signal-to-Noise Rate Specifications	5-66
5-14	Typical Standby Signal-to-Noise Ratio Specifications	5-66
5-15	Harmonic and SMPTE Intermodulation System Distortion Specifications	5-67
5-16	Rotational Rates (Hertz)	5-75
5-17	Troubleshooting Hints — Tape Transport.	5-75
5-18	Troubleshooting Hints — Tape Timer	5-78
5-19	Troubleshooting Hints — Flutter	5-78
5-20	Troubleshooting Hints — Signal-to-Noise Ratio	5-79
5-21	Troubleshooting Hints — Harmonic and Intermodulation Distortion	5-80
5-22	Troubleshooting Hints — General.	5-80



13788-35

ATR-100 Series Recorder/Reproducer Mounted in a Cabinet on a Pedestal with Input/Output Assembly (Accessory)

SECTION 1

GENERAL INFORMATION

This manual provides operation and maintenance instruction for the models ATR-101, ATR-102, and ATR-104 Recorder/Reproducers, Ampex Part No. 4010260 (full track), 4010261 (2 track), and 4010262 (4 track) respectively.

1-1. DESCRIPTION

The ATR-100 series Recorder/Reproducers are professional quality audio tape recorder/reproducers that use 1/4-inch (6.4 mm) or 1/2-inch (12.7 mm) wide magnetic tape on EIA or NAB reels up to 14 inches (35.56 cm) in diameter. The recorder/reproducer can operate in either the NAB or IEC equalization standard at any two speeds selected from the following speeds: 3.75, 7.5, 15, and 30 in/s (9.5, 19.05, 38.1 and 76.2 cm/s).

A plug-in-type head assembly permits easy conversion between one- and two-channel operation using 1/4-inch tape, or four-channel operation using 1/2-inch tape. The system is available in five different mounting configurations: cabinet, cabinet mounted on a roll-around pedestal, fixed-rack mount, slide-rack mount, and portable case.

The recorder/reproducer does not incorporate a capstan pinchroller but controls tape movement in all modes of operation while under capstan and reel servo control. The capstan servo controls speed and direction while the reel servo maintains dynamically constant tape tension in all modes of operation.

The basic system incorporates such standard features as an electronic tape timer, Sel-Sync*, PURC (Pick-up Recording Capability), dynamic braking, ceramic tape guides, and ferrite heads. The tape

timer displays in hours, minutes and seconds (or minutes, seconds, and tenths of seconds by changing a jumper) the distance the tape has moved from a zero reference point. The Sel-Sync feature permits the recording of added channels in perfect synchronization with previously recorded channels. The PURC feature eliminates the problem of overlaps and holes in recordings when inserting (dubbing) new material within previously recorded programs. The system does not have mechanical brakes, but incorporates dynamic braking to control all reel braking functions including stopping tape motion when power is removed.

The basic recorder system (Figure 1-1) consists of a tape transport, head assembly, control unit, electronics assembly, and power supply assembly.

1-2. Tape Transport

All components of the tape transport (Figure 1-2) are mounted on a rigid, precision-machined cast-aluminum base, which also serves as a transistor heatsink for the power supply, tension arm solenoid drivers, and motor drive amplifiers. Mechanical features permit changing from one tape width to the other in less than a minute. The tape transport consists mainly of subassemblies which are easily removed and installed without the need for shims. Electrical connections are made by harness connectors, thereby eliminating the need for soldering.

Basic components of the tape transport are the capstan, supply and takeup motors, supply and takeup constant-tension arms, and tape timer wheel assembly. Tape motion is controlled in all modes of operation (including fast forward, rewind, and spool) by the capstan and reel servos. The capstan turns to meter the tape and the constant-tension arms supply arm position information to the reel servo system. This arrangement results in constant tape tension in all modes of operation.

*Trademark, Ampex Corporation

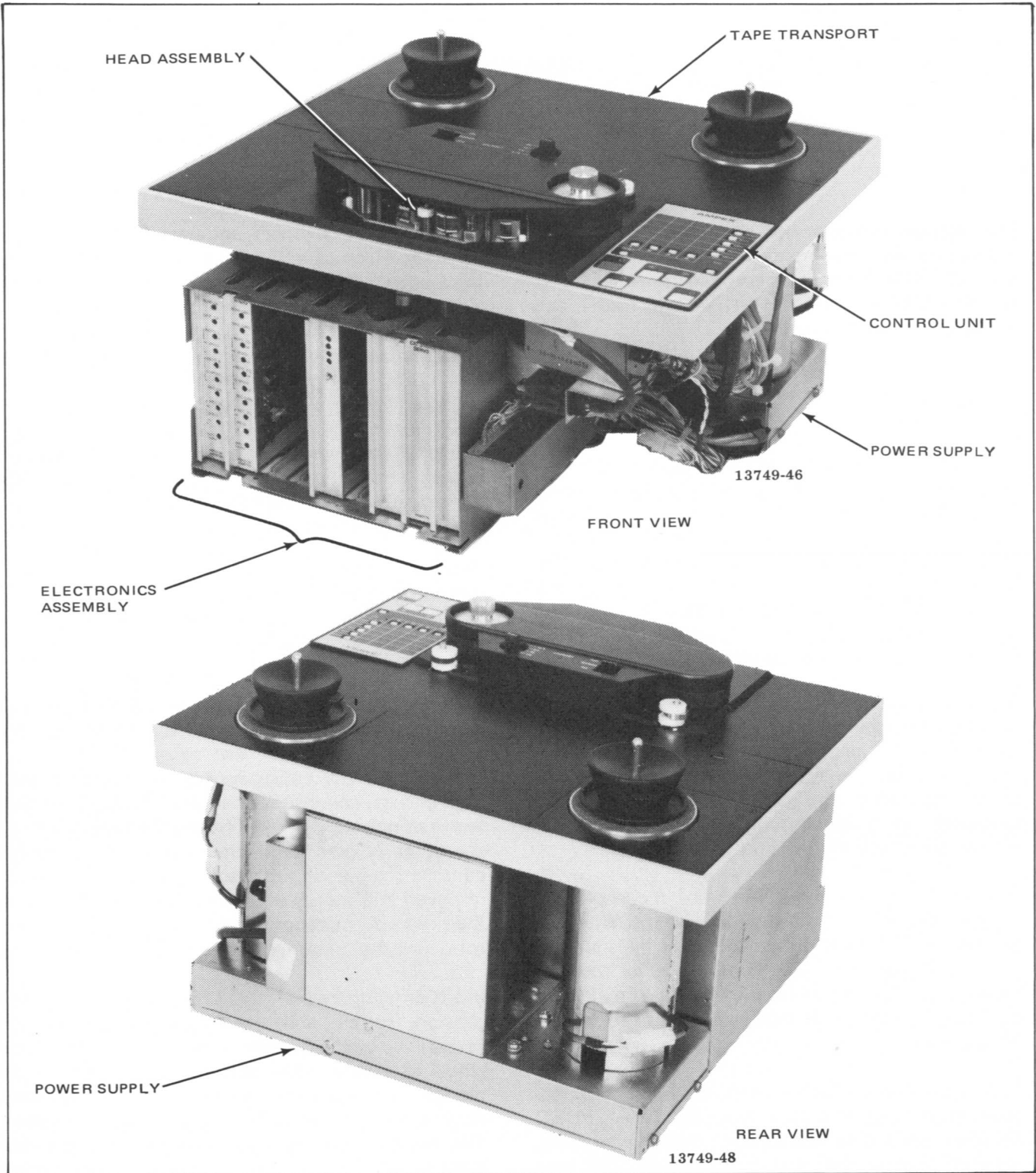

Figure 1-1. Recorder/Reproducer, Unmounted

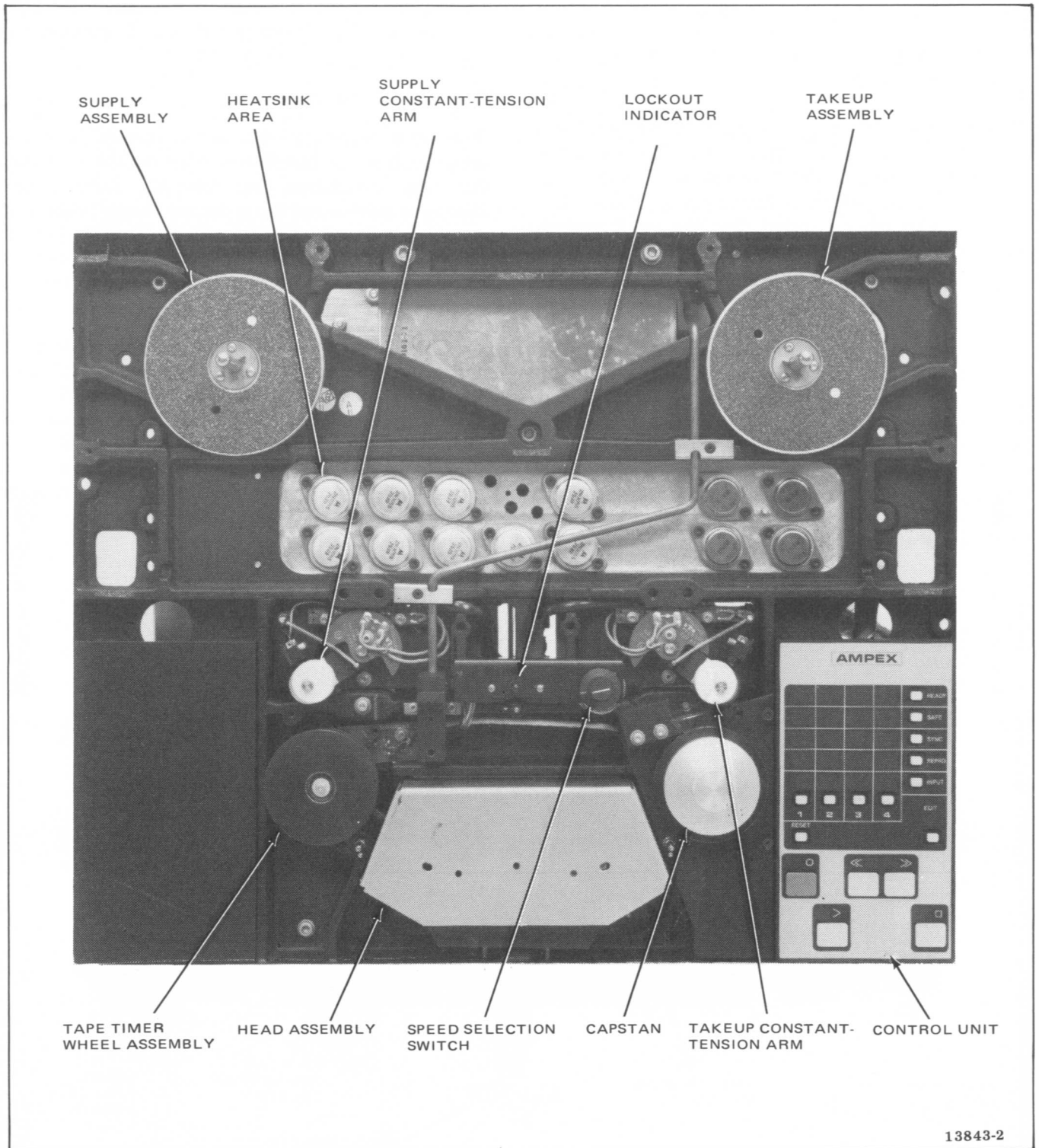

Figure 1-2. Top View of Tape Transport with Front and Rear Overlay Panels and the Head Cover Removed

Tape motion causes the tape timer wheel to rotate and a photo-electric device, located below the tape timer wheel, provides rotational information to the tape timer circuitry.

Tape speed is selected by operating a rotary switch, located on the tape transport, that also causes the equalization bias, PURC timing, and tape timer circuitry to be switched according to speed selection. If a speed is selected that the signal system has not been set for, a LOCKOUT indicator lights and the play and record modes for that speed are inoperative.

The transport will accommodate tape reels up to 14 inches (35.56 cm) in diameter in any combination. When reels larger than 11-1/2 inches (29.21 cm) are used, the reel motors must be repositioned to an outer position.

During fast forward, rewind, and spool modes, two solenoid-actuated tape-lifter arms automatically lift the tape from the heads. For editing and

cueing operations, override of the tape-lifter arms is provided by pressing the EDIT pushbutton during these modes of operation.

1-3. Head Assembly

The head assembly is a self-contained unit and plugs into a receptacle mounted on the transport for easy installation and removal. Tape scrape-flutter is minimized by a scrape-flutter idler that is mounted on jeweled bearings and located between the record and reproduce head stacks. An optional second idler may be installed to the left of the erase head.

Figure 1-3 shows a 2-track (1/4-inch tape) head assembly. The erase, record, and reproduce head stacks are mounted in head mounting positions 2, 3, and 4 respectively, but other combinations are possible. Each head stack is mounted on a precision plate and is easily removed from the head assembly by unplugging the head-stack connector and removing the head-stack mounting screw shown in Figure 1-4.

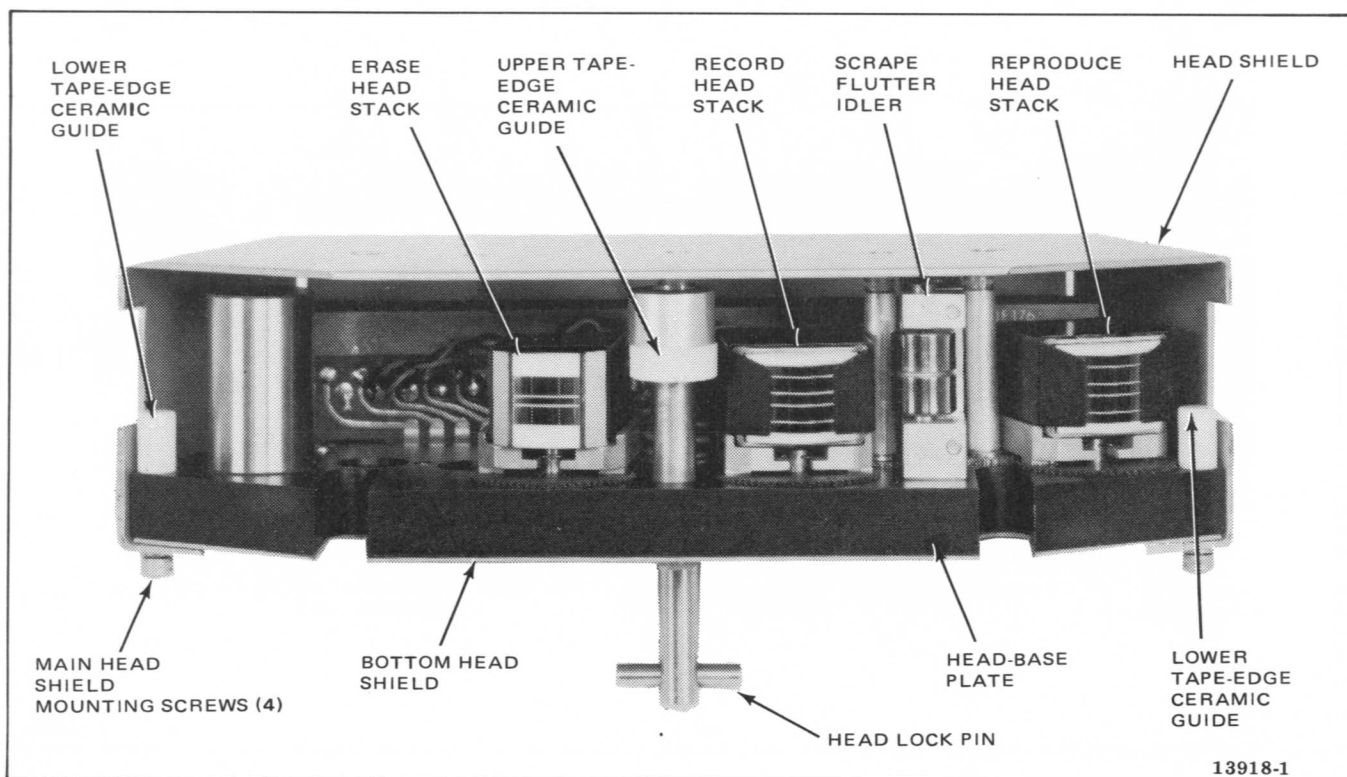

Figure 1-3. Head Assembly

The only head adjustment required is for record and reproduce head-stack azimuth. This adjustment is made by turning a screw which causes a tapered gear to rotate underneath the head-stack precision plate, thereby providing a limited, but adequate, range of adjustment. (The head design has eliminated the need for adjusting tape wrap, height, and zenith.)

The head stacks are made of ferrite material, and the record stack has a dual winding so that record and Sel-Sync functions can be separately optimized.

1-4. Control Unit

The control unit (Figure 1-5) is capable of controlling up to four audio channels, and enables the operator to initiate all transport and signal mode functions from a single control panel. In addition to controlling all transport functions,

such as play, record, fast forward, spool, edit, etc., pushbutton switches associated with each channel enable the operator to program each channel separately for operation in the desired signal mode. This program selection is indicated by light emitting diodes associated with each channel. A tape timer display indicates in hours, minutes, and seconds (or minutes, seconds, and tenths of seconds) the distance the tape has moved from a zero reference point established by pressing a RESET pushbutton switch.

For operator convenience, the control panel may be located either in the left-hand or right-hand position on the transport. An accessory remote control unit with a 25-foot (7.62m) cable is available. This control unit duplicates all functions and displays of the local control unit with the exception that play/edit and stop/edit (unthread) modes may not be initiated.

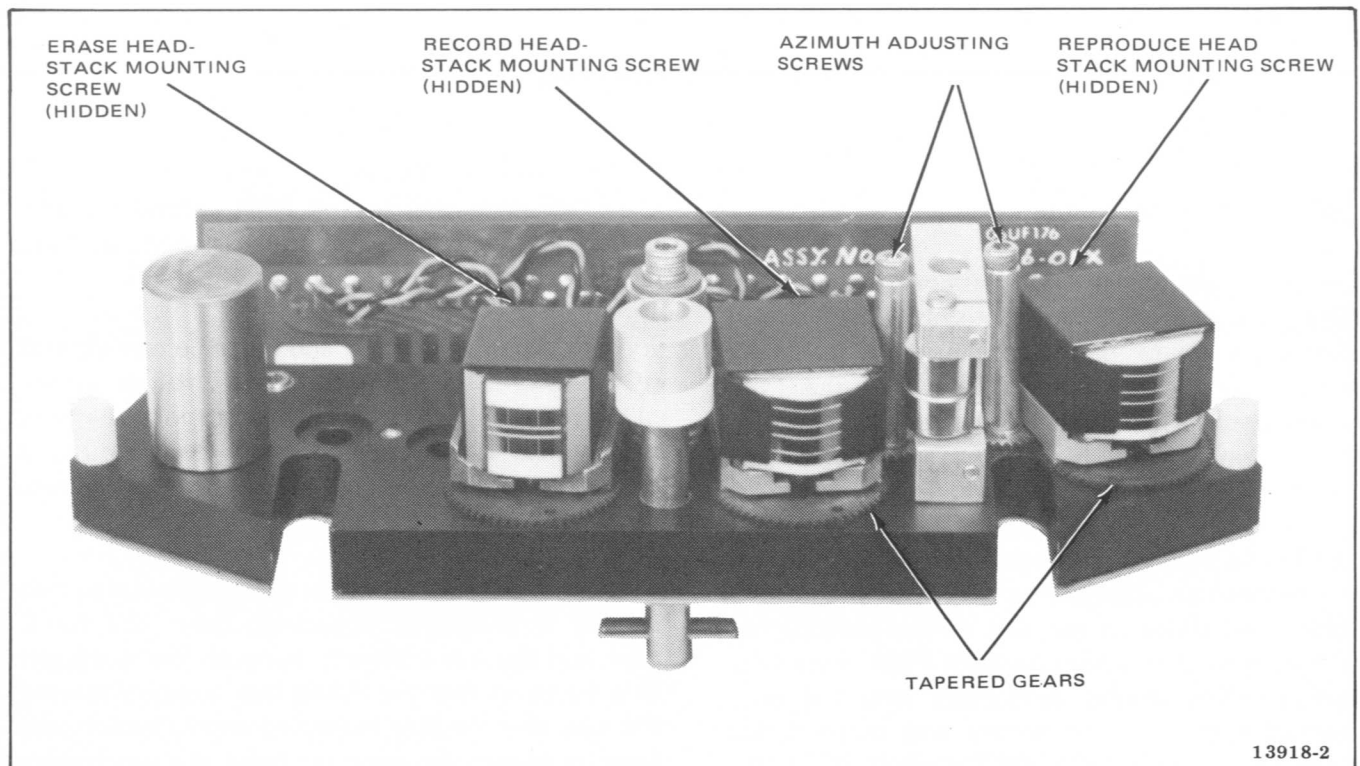

Figure 1-4. Head Assembly with Head Shield Removed

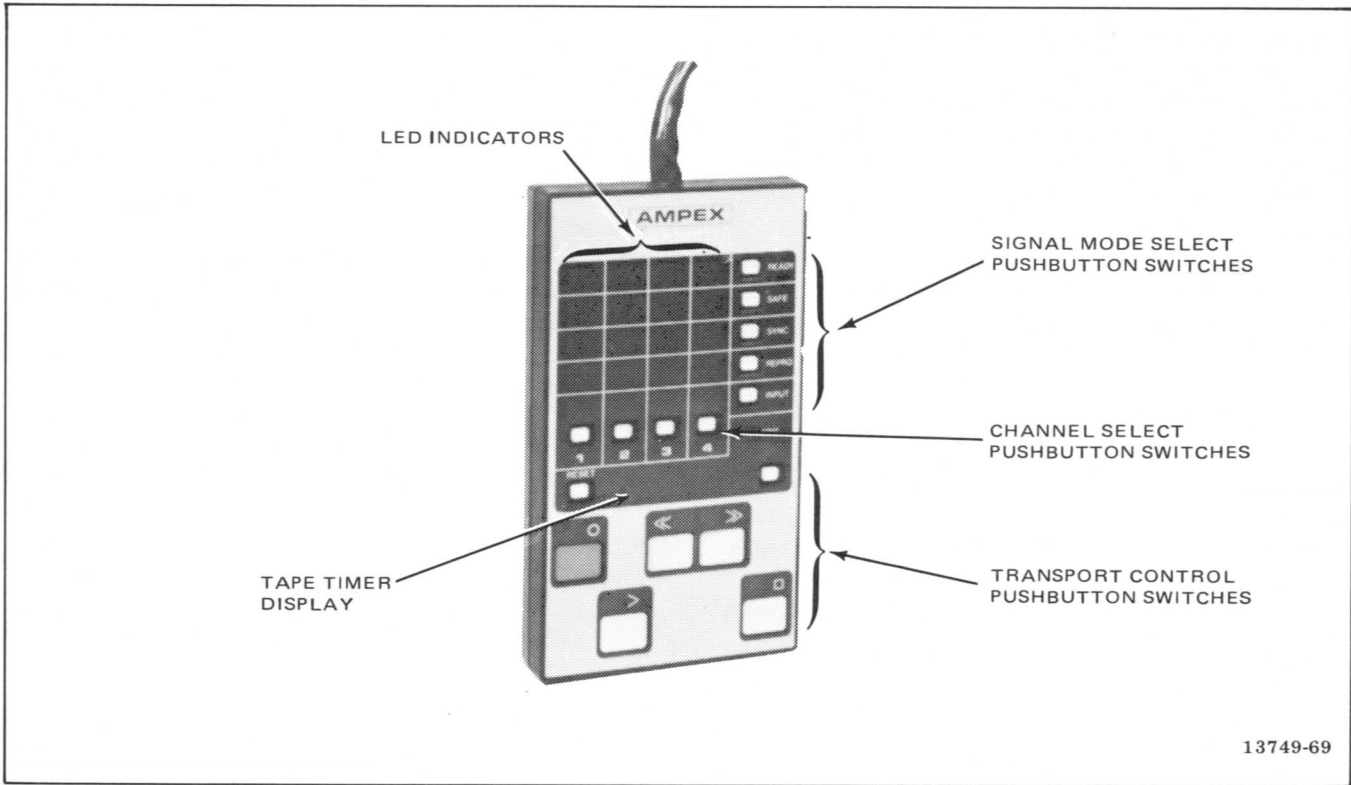

Figure 1-5. Control Unit

1-5. Electronics Assembly

Except for the power supply and motor drive amplifiers, the ATR-100 series Recorder/Reproducer electronics are primarily contained on up to 12 printed wiring assemblies (PWAs) for the four-channel version of the recorder/reproducer. (The four audio channel PWAs are actually double boards.) These PWAs are listed in Table 1-1.

The PWAs plug into a single-row card rack within the electronics assembly as shown in Figure 1-6. Each PWA slides in and out of the assembly on guides; edge connectors on each PWA mate with corresponding female connectors mounted on a motherboard. The connectors and motherboard form part of a harness assembly which routes the PWA signals throughout the recorder/reproducer and to the input/output connectors mounted on

the electronics assembly. A PWA extender board, used for servicing and adjustments, is stored next to the PWAs in the card rack.

In the cabinet, slide rack, and portable case version of the recorder/reproducer, the electronics assembly is mounted directly on the transport as shown in Figure 1-1. The head assembly plugs directly into a connector mounted on the electronics assembly.

In the fixed rack configuration, the electronics chassis is physically separated from the transport and mounted directly beneath the transport in a frame so that the PWAs face outward toward the operator. In this mounting configuration, the head connector is removed from the electronics assembly and is fastened to the transport to receive the head assembly.

Table 1-1. Electronics Assembly Printed Wiring Assemblies

PWA NO.	ASSEMBLY NO.	DESCRIPTION
1-4	4050754 and 4050755	Main Audio PADNET (Parameter Determining Network—plugs into Main Audio PWA.)
5	4050788	Audio Control
6	(Spare)	Can be used to store extender Board Assembly No. 4050800
7	4050787	Transport Control (Transport Logic and Tape Timer)
8	4050776	Capstan Servo
9	4050778	Reel Servo

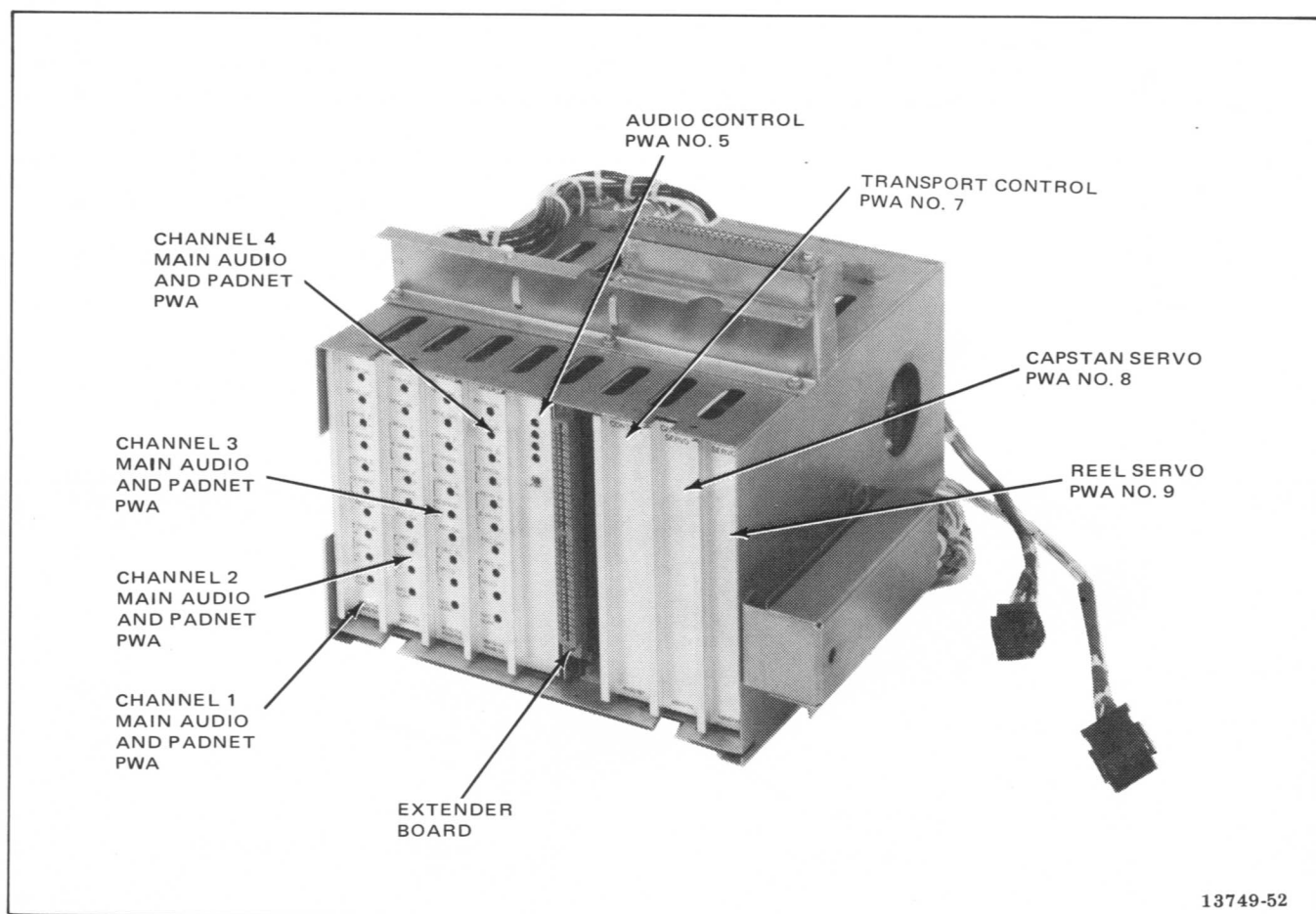

13749-52

Figure 1-6. Electronics Assembly, Cover Panel Removed

1-6. Power Supply

The power supply is a self-contained unit (except for series pass transistors that are mounted on the transport casting) that is easily removed from the transport by disconnecting two connectors and removing three screws. Figures 1-7 and 1-8 show the basic components of the power supply. Main ac power is connected to the ATR-100 through a captive power cable attached to the power switch bracket. A jumper plug arrangement within the power supply chassis adapts the main power transformer to use any one of four input voltage ranges: 90-115, 110-135, 180-230, and 220-270 Vac (50-60 Hz).

The power supply provides the following basic functions:

1. Houses the main power switch and fuses. A mechanical linkage enables the switch to be operated from the top of the transport.

2. Houses the dynamic brake circuitry used for power failure or control-loss braking for the reel motors.
3. Provides regulated +5.0 Vdc for use throughout the system to operate the TTL circuitry.
4. Provides ± 20 Vdc (nominal) for the reel motors and capstan motor.
5. Provides electronically filtered ± 22 Vdc (nominal) for the audio signal system circuitry.
6. Provides 100 Vac (nominal) for operation of the cabinet fan.

1-7. EQUIPMENT CONFIGURATIONS

The recorder/reproducer is available from the factory in a one-channel, two-channel, or four-channel version and may be easily converted from one version to another. Each basic recorder/reproducer

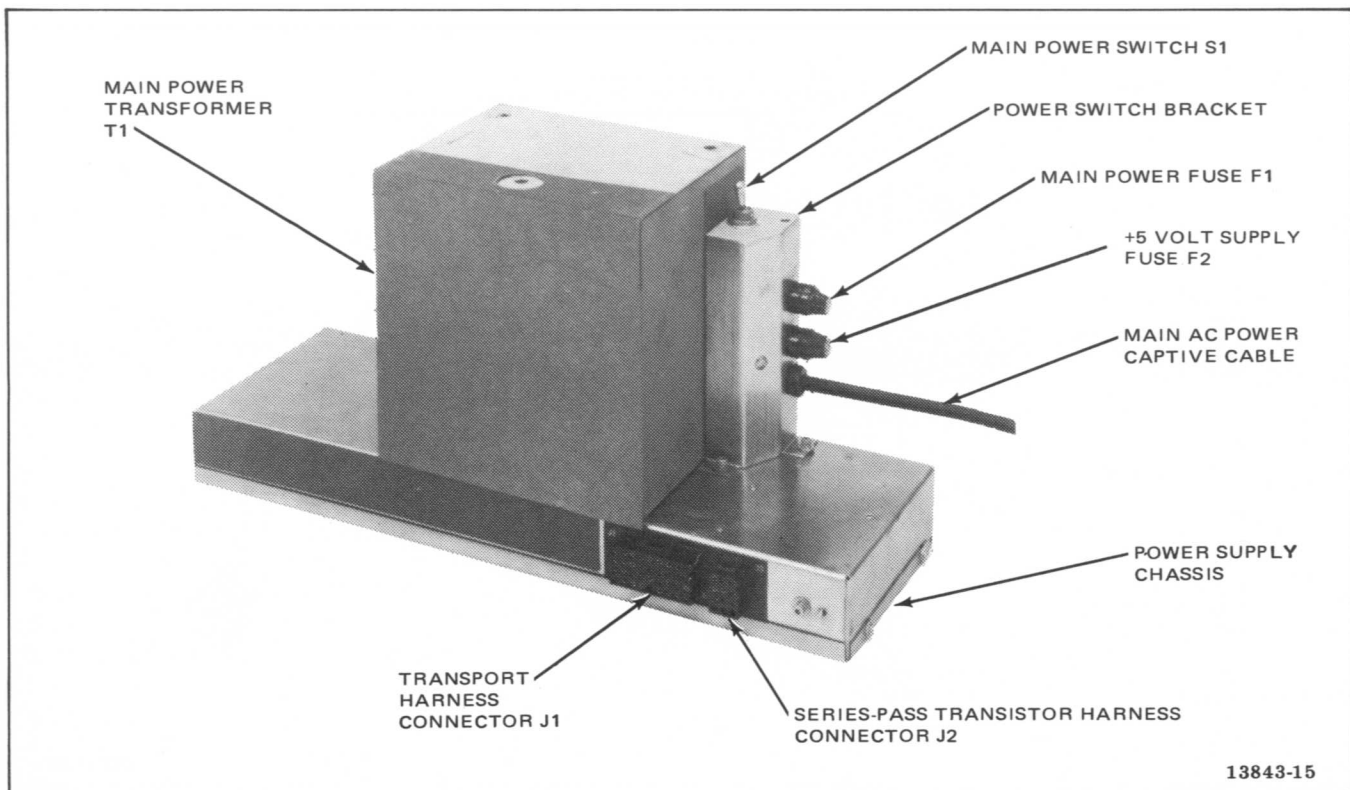

Figure 1-7. Power Supply

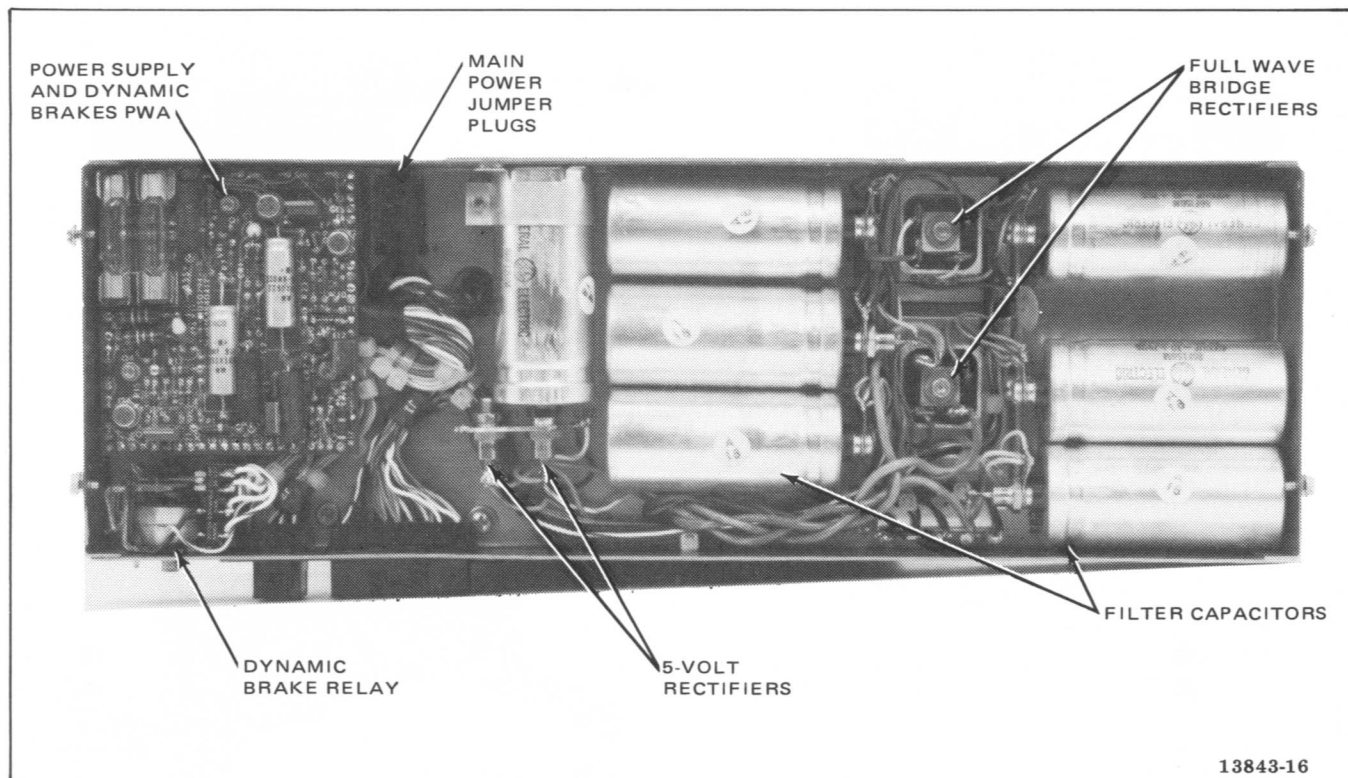

Figure 1-8. Power Supply Chassis with Cover Panel Removed

is prewired for four-channel operation. For example, to convert from two-channel 1/4-inch tape operation to four-channel 1/2-inch tape operation, only the following, easily installed equipment is required: head assembly, supply and takeup guides, two main audio PWAs, and two PADNET PWAs.

In addition, there are five different mounting configurations available: cabinet, cabinet mounted on a roll-around pedestal, fixed-rack mount, slide-rack mount, and portable case. Four of these configurations are shown in Figure 1-9. Available optional equipment that may be used to convert from one channel configuration or mounting configuration to another is listed in Table 1-2.

1-8. ACCESSORIES

Available optional accessories are listed in Table 1-3.

1-9. Input/Output Module and Mainframe

The input/output accessory serves as an interface between the input and output of the ATR-100 to permit the operator to adjust and monitor input and output signal levels. These input and output signals can be balanced or unbalanced line. The accessory includes such features as a switchable peak/vu level meter, input and output line transformers, input and output level controls with preset/manual switch controls, headphone monitoring jack, input amplifier, line output drivers, and bias and erase confidence indicators. One input/output module is used per channel and two input/output modules may be mounted side-by-side in an input/output main frame assembly (Figure 1-10). The main frame accessory may then be installed into an enclosure supplied with the recorder/reproducer cabinet or mounted in a standard 19-inch rack with an optional top cover. Two accessories may be mounted vertically to accommodate a four-channel system.

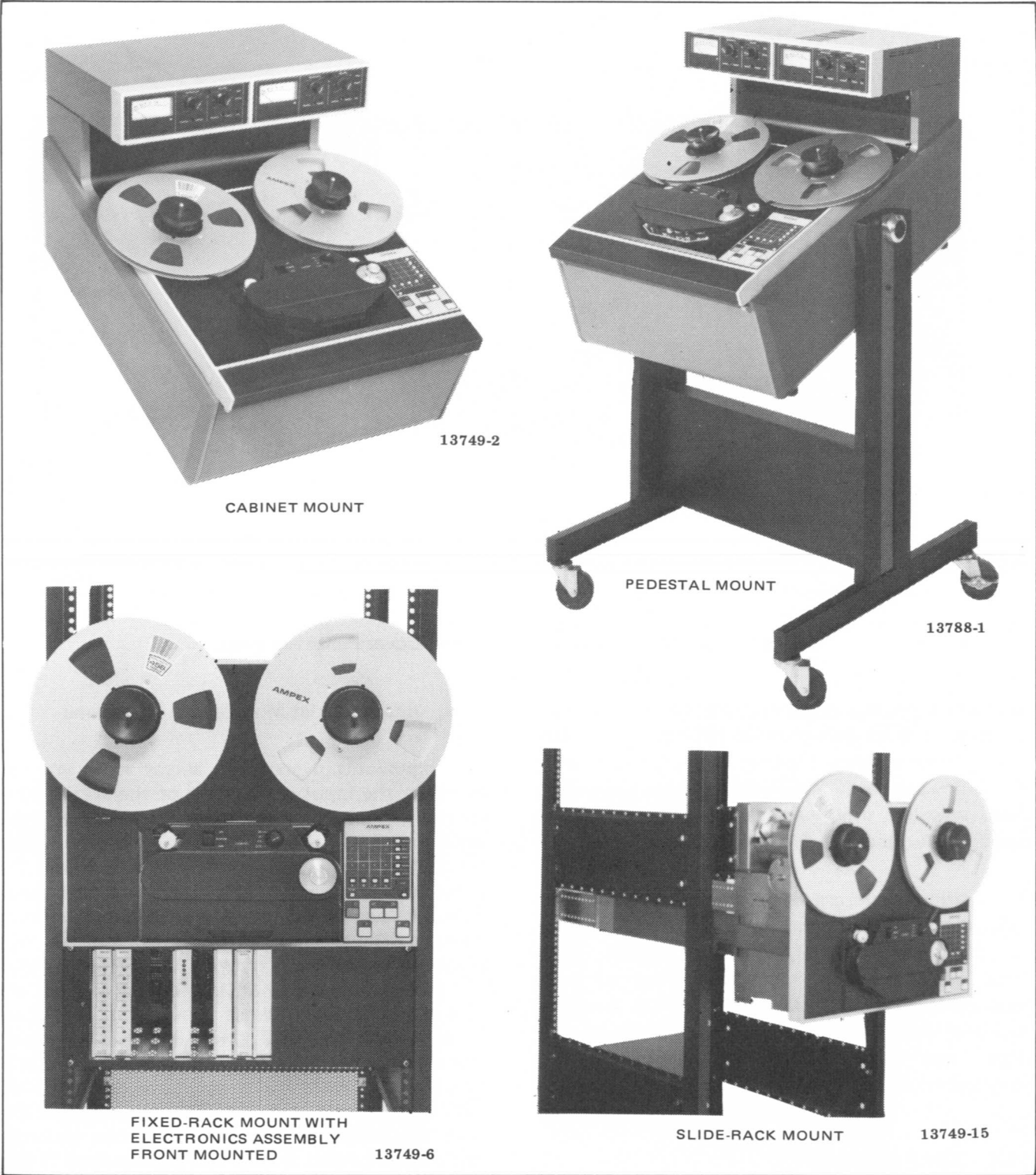

Figure 1-9. ATR-100 Series Mounting Configurations

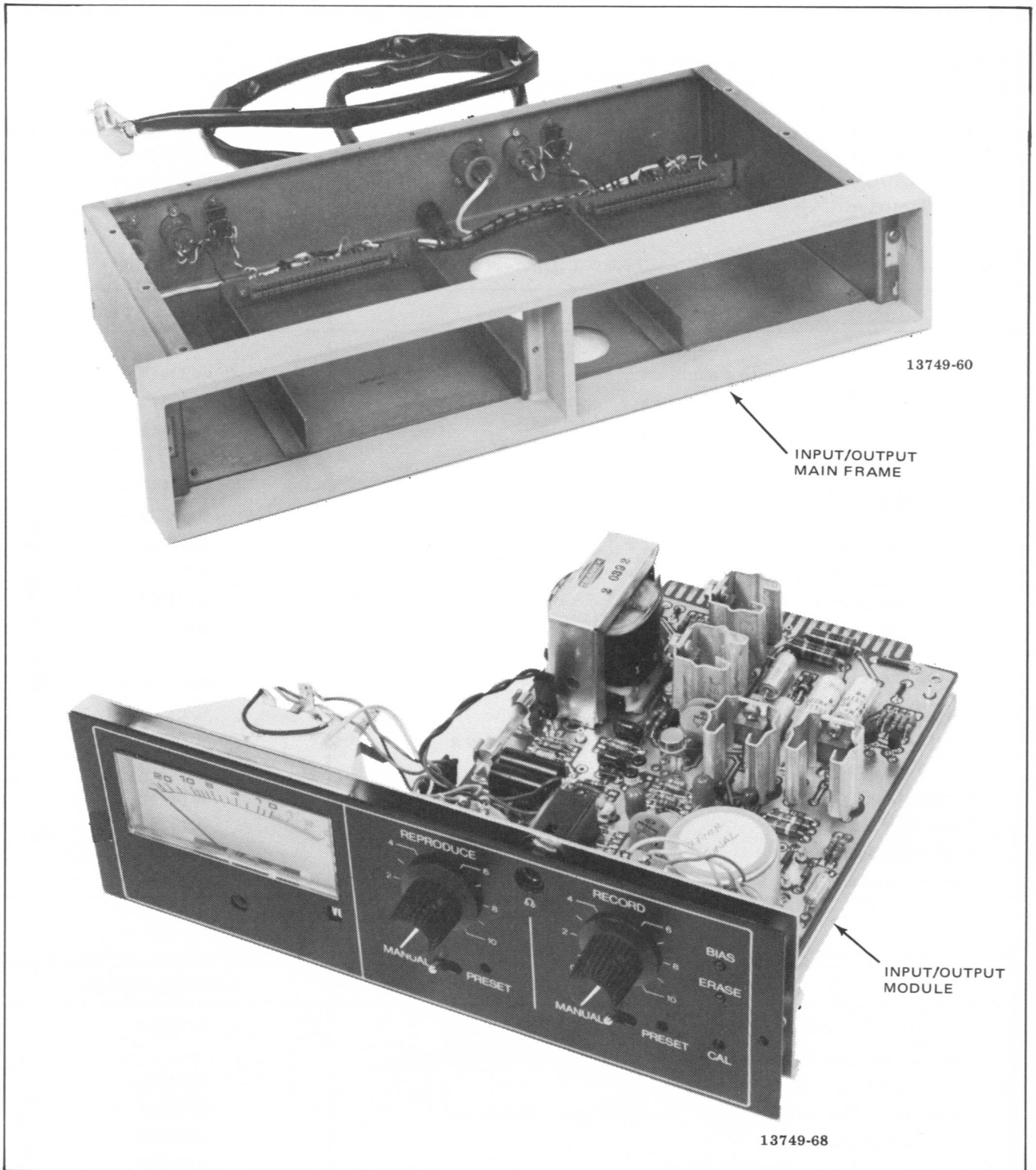

Figure 1-10. Input/Output Assembly

1-10. Remote Control Unit

The remote control unit duplicates all functions and displays of the local control unit with the exception that play/edit and stop/edit (unthread) modes may not be selected. Except for these two modes, the remote control unit operates in parallel with the local control unit at all times. The unit comes equipped with a 25-foot captive cable and

connector for easy connection to the recorder/reproducer.

1-11. SPECIFICATIONS

Specifications for the ATR-100 series Recorder/Reproducers are given in Table 1-4. All specifications are subject to change without notice or obligation.

Table 1-2. Optional Equipment

DESCRIPTION	AMPEX PART NO.
Head Assembly	
Full Track, 1/4-inch (6.4 mm) tape	4020413
Two Track, 1/4-inch (6.4 mm) tape	4020417
Four Track, 1/2-inch (12.7 mm) tape	4020418
Tape Guide Assembly	
Supply 1/4-inch tape	4041239-AA
Takeup 1/4-inch tape	4041239-AB
Supply 1/2-inch tape	4041240-AA
Takeup 1/2-inch tape	4041240-AB
Audio Main Board PWA	4050754
PADNET PWA	4050755
Cabinet Kit Assembly	
1 or 2 Channel	4010258-AC
3 or 4 Channel	4010258-AD
Riser Kit (converts cabinet kit assembly from 1 or 2 channel to a 3 or 4 channel version)	4020429
Portable Case	4010259
Fixed Rack Mount Kit	4010252
Slide Rack Mount Kit	4010253
Pedestal Assembly	4020426

Table 1-3. Accessory Equipment

DESCRIPTION	AMPEX PART NO.
Input/Output Mainframe	4010254
Input/Output Mainframe Cover Kit - used when mounting mainframe into 19-inch (48.26 cm) rack	4020428
Input/Output Module Blank Panel - for Input/Output Mainframe	4041247
Input/Output Module	4020409
Input/Output Module Extender Board	4020430
Input/Output Module Level Set Assembly	4020425

Table 1-3. Accessory Equipment (Continued)

DESCRIPTION	AMPEX PART NO.
Remote Control Unit, Four-Channel — includes 25-foot (7.62 m) captive cable and connector	4010264
Optional Scrape Flutter Idler (not interchangeable with furnished idler)	4030402-AB
Two-Way Extension Accessory Connector Assembly	4020432
Noise Reduction Switching Interface (Dolby/DBX Switcher)	4020433
Flux Loop	4020423
Flux Loop Equalizing Amplifier	4020424
ATR-100 Spare Parts Kits	
“A” Level Spares	1385874
“B” Level Spares	
Full Track	1385875-01
2 Track	1385875-02
4 Track	1385875-03
“C” Level Spares	
1/4-inch (6.4 mm) Tape	1385876-01
1/2-inch (12.7 mm) Tape	1385876-02
VS-10 Variable Speed Oscillator	4010217-07
VS-10 Variable Speed Oscillator with Readout	4010217-08
Edit Code Generator	4010166
Edit Code Reader	4010187

Table 1-4. Specifications

<p>Tape Widths:</p> <p>1/4 inch (6.4 mm) for full-track and 2-track, 2-channel systems, 0.075 inch (1.9 mm) track width.</p> <p>1/2 inch (12.7 mm) for 4-track systems, 0.070 (1.8 mm) track width.</p> <p>Tape Speeds:</p> <p>3.75 in/s (9.5 cm/s)</p> <p>7.5 in/s (19.05 cm/s)</p> <p>15 in/s (38.1 cm/s)</p> <p>30 in/s (76.2 cm/s)</p> <p>(any two speeds may be selected)</p> <p>Reel Size:</p> <p>2-inch to 14-inch diameter (50 mm to 355 mm)</p> <p>Reel Type:</p> <p>NAB, EIA (Cine')</p>
--

Table 1-4. Specifications (Continued)

Inputs (With Input/Output System – Bridging Input Standard):

Balanced, floating
 Input impedance: 50 kilohms, resistive $\pm 5.0\%$, 5 Hz – 20 kHz
 Input level (variable): Minimum: -5 dBm, to produce 1,000 nWb/m record flux level
 Maximum: +40 dBm
 Input clip level, including record amplifier at mid-frequency:
 26 dB above system operating level.
 Input level (preset): -1 dBm to +20 dBm to produce 1,000 nWb/m recorded flux level

Outputs (With Input/Output System):

Balanced, floating
 Output impedance: <50 ohms, 5 Hz – 20 kHz
 Maximum output level: With 600-ohm load: +28 dBm
 With 200-ohm load: +25 dBm
 Preset output level: Line output level is adjustable over a range of +12 dBm to -2 dBm
 Metering: Meters are switchable, vu or peak
 VU ballistics conform to ASA standards
 Peak ballistics conform to EBU standards
 Zero meter reading is continuously adjustable over a range of
 +12 dBm to -2 dBm line level

Inputs (Without Input/Output System):

Unbalanced
 Input impedance: 10 kilohms, minimum, 5 Hz – 20 kHz
 Input level: -5 dBm, nominal, for system operating level
 (-5 dBm input level provides 26-dB clip level margin at mid-frequency)

Outputs (Without Input/Output System):

Unbalanced
 Output impedance: 40 ohms, 5 Hz – 20 kHz
 Minimum load impedance: 5 kilohms
 Output level: -5 dBm, nominal, for system operating level
 (-5-dBm output level provides 26-dB clip level margin at mid-frequency)

Equalization:

Any two speeds of the four available are jumper selectable. These two speeds are then automatically switched with transport speed switch. Each speed selected provides equalization adjustable over the range of AES/NAB/IEC/CCIR standards.

Overall Frequency Response:

Speed	Ref. Freq.	Within ± 0.75 dB	Within ± 2.00 dB	REFERENCE LEVEL* (0 is operating level)
30 in/s (76.2 cm/s)	1 kHz	200 Hz – 20 kHz	35 Hz – 28 kHz	0
15 in/s (38.1 cm/s)	1 kHz	100 Hz – 15 kHz	20 Hz – 20 kHz	0
7.5 in/s (19.05 cm/s)	500 Hz	100 Hz – 10 kHz	30 Hz – 15 kHz	-10 dB
3.75 in/s (9.52 cm/s)	500 Hz	—	30 Hz – 10 kHz	-20 dB

*Operating level is 370 nWb/m at 700 Hz for Ampex 456 tape, and 260 nWb/m at 700 Hz for Ampex 406/407 tape.

Table 1-4. Specifications (Continued)

Signal-to-Noise Ratio:

Overall signal to noise ratio at 7.5 – 30 in/s is measured with respect to a record level of 1040 nWb/m (9 dB above an operating level of 370 nWb/m) when using Ampex 456 tape or direct equivalent. At 1040 nWb/m mid-frequency, third harmonic distortion is less than 3%.

Tape Speed and Equalization	Track Format	30 Hz – 18 kHz Unweighted	ANSI "A" Weighted	IEC/CCIR Rec 468 Weighted
30 in/s AES	Full track	77 dB	81 dB	73 dB
	2 track & 4 track	72 dB	76 dB	67 dB
15 in/s IEC/CCIR	Full track	74 dB	78 dB	70 dB
	2 track & 4 track	70 dB	74 dB	65 dB
15 in/s (38.1 cm/s) NAB	Full track	73 dB	77 dB	69 dB
	2 track & 4 track	69 dB	73 dB	63 dB
7.5 in/s (19.05 cm/s) NAB	Full track	75 dB	78 dB	70 dB
	2 track & 4 track	71 dB	74 dB	63 dB
7.5 in/s (19.05 cm/s) IEC/CCIR	Full track	71 dB	76 dB	67 dB
	2 track & 4 track	68 dB	71 dB	62 dB
*3.75 in/s (9.52 cm/s) IEC/NAB	Full track	68 dB	72 dB	64 dB
	2 track & 4 track	64 dB	66 dB	57 dB

*At 3.75 in/s, overall signal-to-noise ratio is measured with respect to a record level of 740nWb/m (6 dB above operating level of 370 nWb/m). At 740 nWb/m, mid-frequency, third harmonic distortion is less than 3%.

System Distortion:

Electronics Distortion:

System electronics distortion, including record amplifier, reproduce amplifier and Input/Output system, at any operating level up to 20 dB above operating level at mid-frequency is <0.03% total harmonic distortion and <0.05% SMPTE intermodulation distortion.

Overall record/reproduce distortion (using Ampex 456 tape or direct equivalent):

At system operating level (0 vu = 370 nWb/m; 6 dB above 185 nWb/m)

Even Order Distortion:

Even order distortion of a 1-kHz signal recorded at 370 nWb/m is less than 0.1%.

7.5 in/s - 30 in/s:

Third Harmonic Distortion at 1 kHz: <0.3% at recorded flux level of 370 nWb/m (0 vu)
<3.0% at recorded flux level of 1040 nWb/m (+9 vu)
SMPTE Intermodulation Distortion: <1.0% at recorded flux level of 370 nWb/m (0 vu)

3.75 in/s

Third Harmonic Distortion at 500 Hz: <0.5% at recorded flux level of 370 nWb/m (0 vu)
<3.0% at recorded flux level of 740 nWb/m (+6 vu)
SMPTE Intermodulation Distortion: <2.0% at recorded flux level of 370 nWb/m (0 vu)

Table 1-4. Specifications (Continued)

Crosstalk:

Crosstalk is measured by simultaneously placing the channel under test, and an adjacent channel in-record mode. The adjacent channel is fed with an operating level signal, the channel under test has its input shorted. The residual signal on the reproduced output of the channel under test relative to operating level, is less than 45 dB, 100 Hz – 15 kHz at 15 in/s for 2-track.

Erase Depth:

Using Ampex 456 tape or direct equivalent at any wavelength shorter than 75 mils (200 Hz @ 15 in/s) recorded 6 dB above system operating level: 85 dB minimum

Erase Frequency: 144 kHz

Bias Frequency: 432 kHz

(Both bias and erase frequencies are derived from master crystal oscillator)

Speed Accuracy:

(Using 1.0 – 1.5-mil base film thickness tape)

Absolute speed accuracy: $\pm 0.03\%$

Speed variation from beginning to end of reel: 0.02% maximum

Flutter and Wow:

Speed	ANSI S 4.3/DIN	ANSI/DIN	NAB
	45507 Peak Weighted	Peak Unweighted	RMS Unweighted
3.75 in/s (9.52 cm/s)	$\pm 0.1\%$	$\pm 0.15\%$	0.1%
7.5 in/s (19.05 cm/s)	$\pm 0.05\%$	$\pm 0.12\%$	0.06%
15 in/s (38.1 cm/s)	$\pm 0.03\%$	$\pm 0.08\%$	0.04%
30 in/s (76.2 cm/s)	$\pm 0.03\%$	$\pm 0.08\%$	0.03%

Start Time:

Speed	Time to attain flutter specification
3.75 in/s	150 ms
7.5 in/s	200 ms
15 in/s	300 ms
30 in/s	500 ms

Stop Time:

5.0 seconds from fast wind modes

2.0 seconds from spooling mode

0.7 second maximum from play mode (30 in/s, 76.2 cm/s)

Rewind Time:

Normal fast wind modes: 60 seconds for 2400-foot (731.52 m) reel

Spooling modes, for 2400-foot (731.52 m) reel: 180 in/s (457.2 cm/s) – 2.7 minutes

60 in/s (152.4 cm/s) – 8.0 minutes

Electronic Tape Timer:

Tape driven; reads in hours, minutes and seconds (option: minutes, seconds and tenths of seconds)

Absolute accuracy: $\pm 0.05\%$ [1 second in 2400-foot (731.52 m) reel at 15 in/s (38.1 cm/s)]

Table 1-4. Specifications (Continued)

Heads:	
Ferrite, precision mounted	
Full track:	1/4-inch (6.4 mm)
2-track:	1/4-inch (6.4 mm)
4-track:	1/2-inch (12.7 mm)
Size:	
Basic machine (including transport, power supply and audio and servo electronics):	19 inches (48.26 cm) wide x 15.72 inches (39.93 cm) high x 12 inches (30.48 cm) deep
Cabinet (1 or 2 channel):	21 inches (53.34 cm) wide x 19 inches (48.26 cm) high x 32 inches (81.28 cm) deep
Cabinet (4 channel):	21 inches (53.34 cm) wide x 23 inches (58.42 cm) high x 34 inches (86.36 cm) deep
Input/Output system (1 or 2 channel):	19 inches (48.26 cm) wide x 3-1/2 inches (8.89 cm) high x 10 inches (25.4 cm) deep
Complete system (including basic machine, 4-channel cabinet, Input/Output system and roll-around pedestal):	26 inches (66.04 cm) wide x 46-1/2 inches (118.11 cm) high x 34 inches (86.36 cm) deep
Weight:	
Basic machine:	125 lbs (56 kg)
Cabinet:	15 lbs (7 kg)
Input/Output system (2 channel):	15 lbs (7 kg)
Pedestal:	50 lbs (23 kg)
Power Line Requirements:	
90-115, 110-135, 180-230, 220-270 Vac, 50/60 Hz	
Power Consumption:	
0.6 kVA maximum (with all accessories)	
Environmental Operating Specifications:	
Temperature:	10° – 50°C (50° – 122°F)
Humidity:	20 – 95%, non-condensing

SECTION 2

INSTALLATION

This section of the manual provides information about unpacking and inspection; choosing the installation site; mounting configurations; equipment connectors and cabling; remote control installation; and initial adjustments including turntable and control unit relocation, spool speed selection, play/edit mode operation lockout, record mode operation lockout, tape timer display selection, and PURC operation selection. Also included is an initial checkout procedure, a discussion of the recorder/reproducer factory-shipped operational configuration, and a procedure for checking operating level.

2-1. UNPACKING AND INSPECTION

The ATR-100 series system is shipped in a specially constructed packing case to protect the equipment during transit. When unpacking the unit, use caution to avoid damage to the recorder finish or accessory parts. Remove all material used to secure certain components during shipment. Check the contents of the packing case and packing materials against the packing list to make sure the shipment is complete. Save the packing case and packing materials for shipment of the equipment to another location.

Carefully examine the contents for damage that may have occurred during shipment. Notify the carrier and the local Ampex representative of any shortage or damage.

2-2. INSTALLATION SITE

The area chosen for operation of the recorder/reproducer should be adequately ventilated and free of vibration. Surrounding air should be dust

free with a temperature range within 60° to 105° Fahrenheit (15.6° to 40.5° Centigrade) and humidity within 50 to 90% (non condensing). The area should not be close to any strong electromagnetic fields. Common sources of interference are fluctuating loads on nearby high current lines, heavy-duty transformers, elevator motors, and radio and television transmitting equipment.

When mounting the equipment, allow sufficient space at the top, bottom, and rear of the unit to permit a flow of cooling air.

2-3. MOUNTING THE RECORDER/REPRODUCER

Use these instructions for mounting the recorder in one of the following configurations: console mount, console mounted on a pedestal, fixed rack mount, and slide-rack mount. Mounting dimensions for rack-mount installation are shown in Figure 2-1.

2-4. Cabinet Mount

In the cabinet mount configuration, the recorder/reproducer transport and electronics are mounted in a cabinet that can be placed on any firm flat surface. To mount the recorder/reproducer in a cabinet, proceed as follows:

NOTE

Prior to mounting the recorder/reproducer in a cabinet, perform any desired *Initial Adjustment* procedures (paragraph 2-21), and perform the *Checking Cables and Components* procedure (paragraph 2-11).

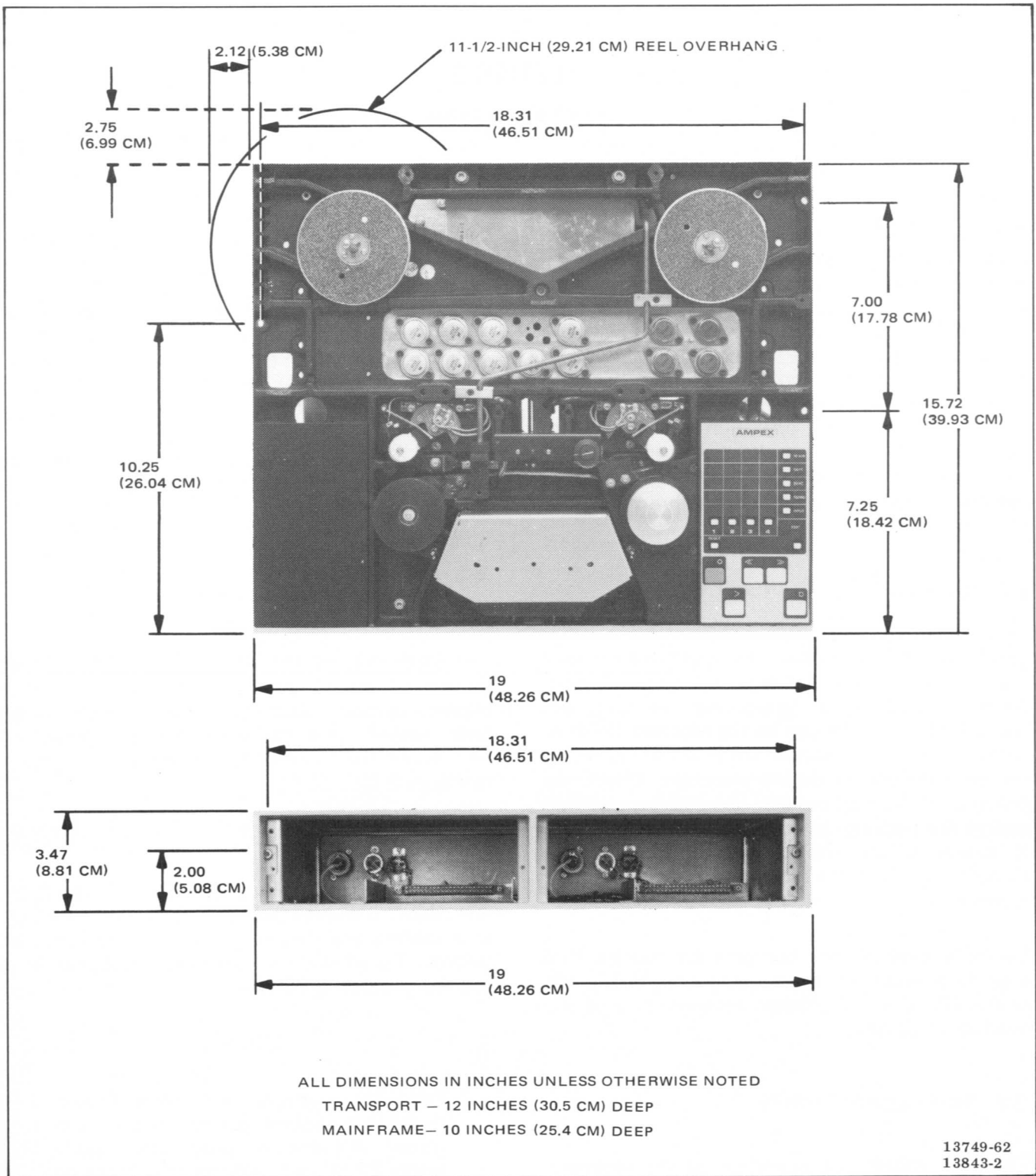

Figure 2-1. Mounting Dimensions

1. At the top of the transport, remove the rear overlay panel (six screws) shown in Figure 2-2.
2. Locate the three transport mounting holes (0.257-inch in diameter) shown in Figure 2-3.
3. For ease of recorder/reproducer installation, remove the front extrusion assembly (arm rest) from cabinet by removing two screws.
4. Mount the transport into the cabinet using three 10-32 socket head screws provided with the cabinet.
5. Connect cabinet fan connector P20 to power supply connector P20.
6. Reinstall rear overlay panel (six screws).
7. Reinstall arm rest (two screws).

2-5. Cabinet Mounted on a Pedestal

In the cabinet mounted on a pedestal configuration, the cabinet is mounted on a pedestal (Figure 2-4) that permits the cabinet to be rotated and placed in any one of five fixed operating positions, or rotated to any desired position for servicing. Proceed as follows:

1. Refer to Figure 2-5 and assemble pedestal as follows:
 - a. Fasten each weldment to the panel assembly using three 1/4-20 X 1/2 inch long cap-head hex socket screws, 1/4 split lock washers and 1/4 plain washers. (Place lock washer between screw and flat washer.)

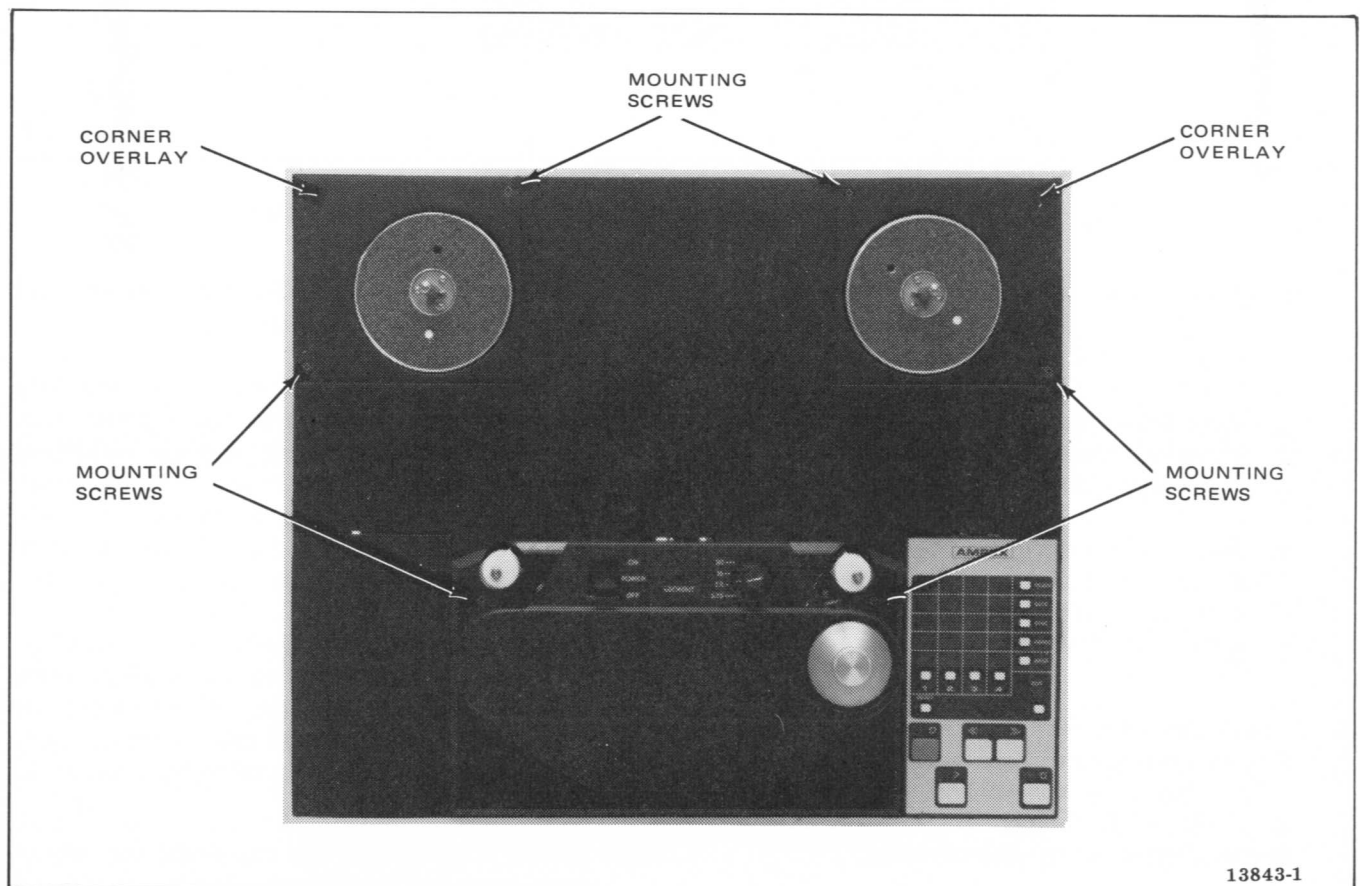

Figure 2-2. Rear Overlay Panel, Six Mounting Screws

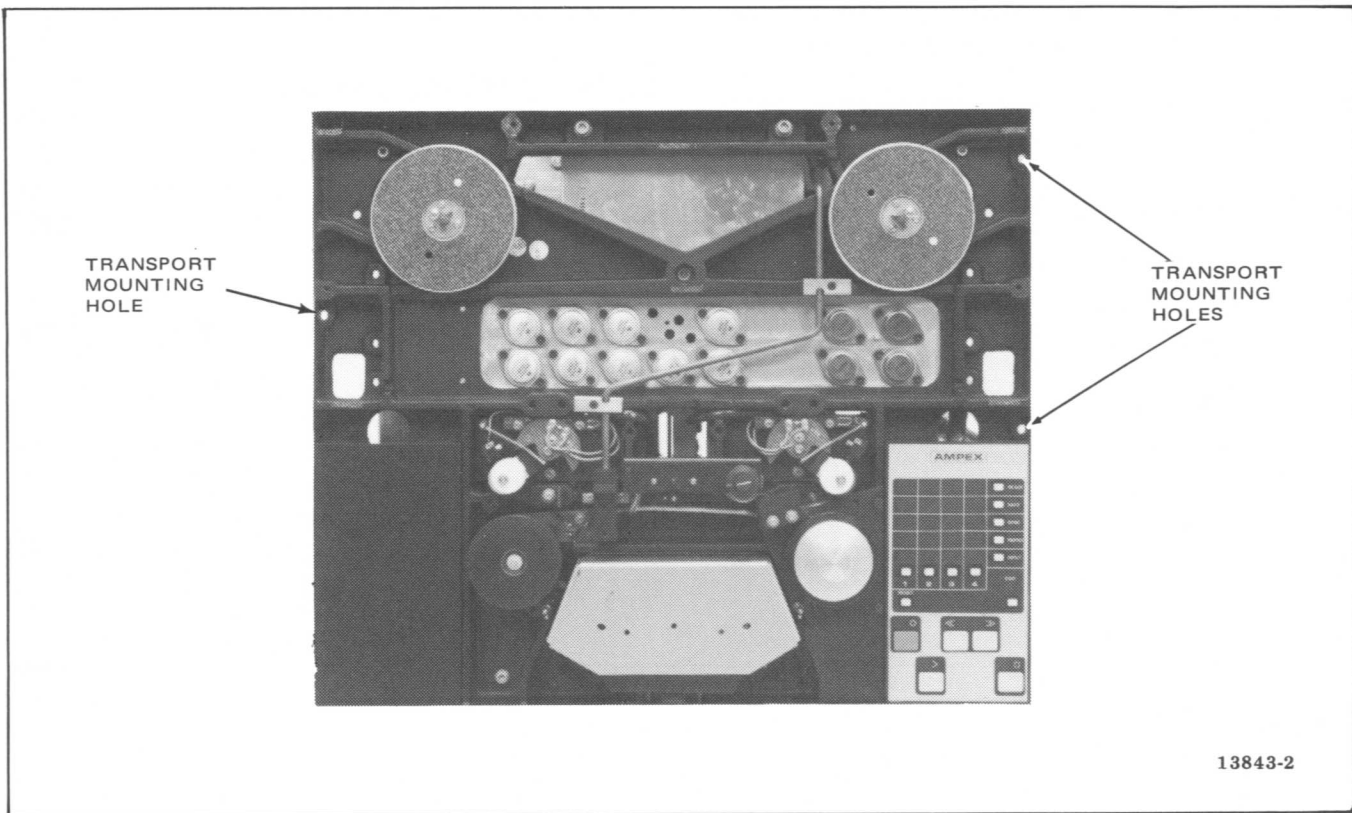

Figure 2-3. Cabinet and Fixed-Rack Mount Transport-Mounting Holes

- b. Install two swivel castors with brakes (front) and two swivel castors without brakes (rear) as shown in Figure 2-5. Castors are installed by screwing the threaded stud of the castor into the threaded insert at the bottom of the pedestal weldment.
 - c. Install a trim strip on the outside surface of each pedestal weldment. Secure each trim strip with two 10-32 \times 1/2 inch long button-head hex-socket screws.
2. Install a pivot plate to each side of the cabinet. Secure each pivot plate with two 1/4-20 \times 1-1/4 inch long screws and two 5/8 OD \times 9/32 ID \times 1/16 inch thick plain washers (factory attached to cabinet sides).
 3. With the pedestal in an upright position and castors with brakes in the front position, have two people (one in front and one in back) lower cabinet onto pedestal.
 4. Install (finger tight) a 1/4-20 \times 1 inch long cap-head hex-socket screw into pivot lock boss on the side of each pedestal weldment (boss extends through hole in trim strip). This screw is used to lock the cabinet pivot plate to any one of five fixed positions; each position is 10 degrees apart.
 5. Install a knob and a 0.562 ID \times 1.12 OD plain nylon washer onto each pivot plate stud. The knobs are used to secure cabinet in place on pedestal (and are also convenient handles for pushing the pedestal around on its castor wheels).
 6. Install a decorative top cap onto the top of each pedestal weldment. Secure each top cap with two 6-32 \times 0.375 button-head hex-socket screws.

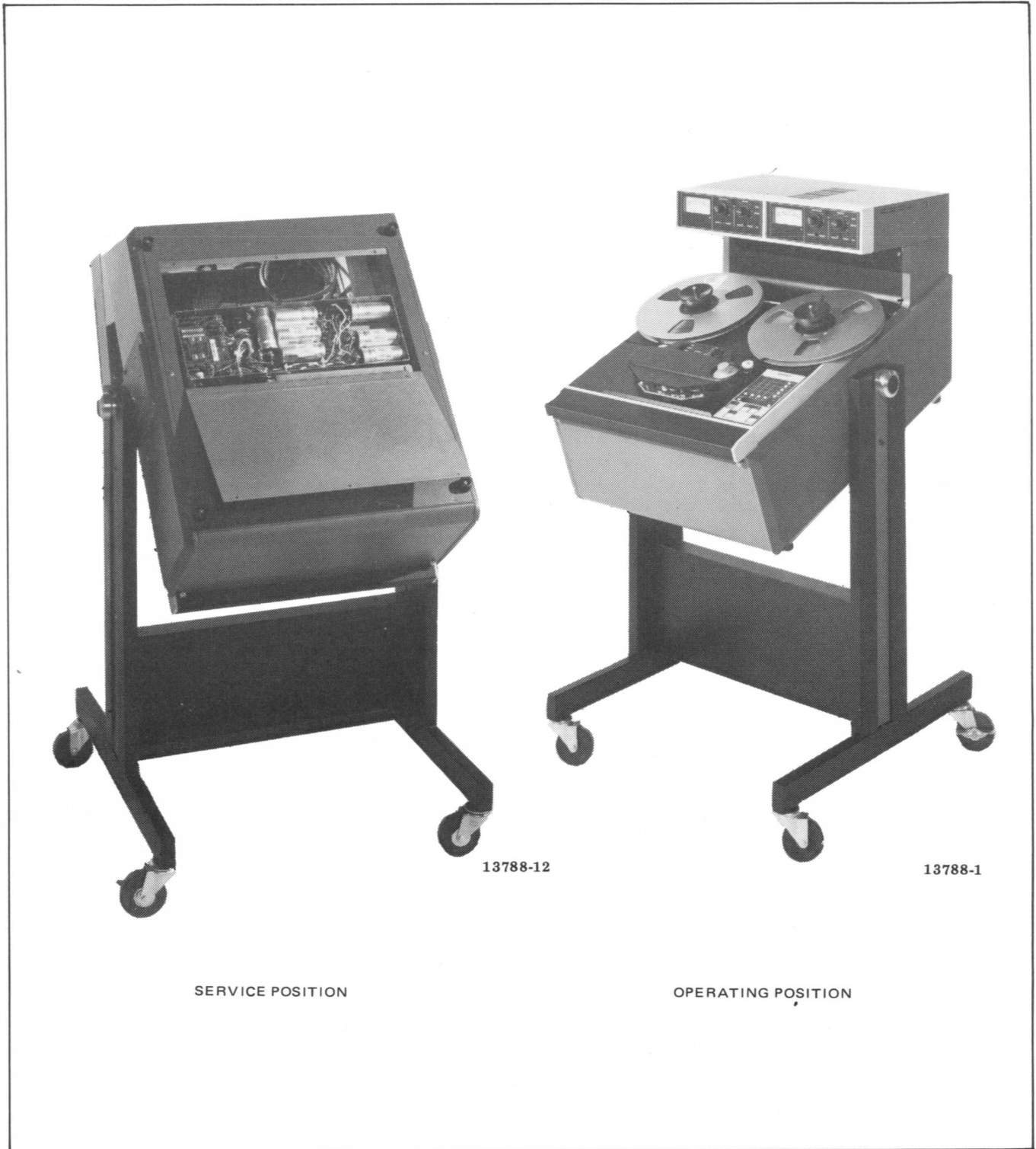

Figure 2-4. Cabinet Mounted on a Pedestal

2-6. Fixed-Rack Mount

In the fixed-rack configuration (Figure 2-6), the electronics assembly chassis is separated from the transport and is mounted directly beneath the transport so that the printed wiring assemblies (PWAs) face forward toward the operator. This equipment is mounted in a standard 19-inch rack or in a custom cabinet as follows:

1. At the top of the transport, remove the rear overlay panel (six screws) shown in Figure 2-2.
2. Locate the three transport mounting holes (Figure 2-3) that are used to mount the transport.
3. Mount the transport onto the rack or custom cabinet using three appropriate size screws, depending on the type of rack or cabinet.
4. Mount the electronics frame furnished in the fixed-rack mount kit directly beneath the transport using four appropriate-size screws, depending on the type of rack or cabinet.
5. Remove the front cover from the electronics assembly and remove all PWAs from the inside of the assembly.

CAUTION

FOR THE FOLLOWING STEPS, DO NOT PUT EXCESSIVE STRAIN ON CABLES OR CONNECTORS. CLIP CABLE TIE DOWNS AS REQUIRED.

6. From the inside of the electronics assembly chassis, remove three 6-32 screws that secure the head cable assembly to the electronics chassis.
7. Carefully unhook electronics assembly chassis, from transport and rotate chassis so that interior of chassis faces forward. Slide chassis into flanges of electronics frame.
8. Secure electronics assembly chassis to electronics frame with four 6-32 screws and a lockwasher under screw head.

9. Reinstall PWAs removed in step 6.

2-7. Slide Rack Mount

In the slide-rack mount configuration (Figure 1-9), the recorder/reproducer is mounted on a pair of slides (Figure 2-7) that are attached to a 19-inch (48.26 cm) rack that has both front and rear rack-mounting members. When installed, the recorder/reproducer may be pulled forward on the slides and rotated 90° upward to permit easy access to the PWAs within the electronics assembly. The slides enable the transport to be extended far enough from the rack to permit 90° rotation of the transport when 14-inch (35.56 cm) reels are mounted on the transport.

WARNING

THE RACK USED TO MOUNT THE RECORDER/REPRODUCER MUST BE SECURELY FASTENED TO THE RACK MOUNTING SURFACE TO PREVENT THE RACK FROM TIPPING FORWARD WHEN THE RECORDER/REPRODUCER IS EXTENDED FORWARD.

All parts and hardware for mounting the recorder/reproducer are furnished in the slide-rack mount kit, Ampex Part No. 4010253. Mount the disassembled slide-rack mount kit parts as follows:

1. At the top of the transport, remove the rear overlay panel (six screws shown in Figure 2-2).
2. Locate the six transport mounting holes (Figure 2-8) that are used to mount the transport to the pivot bracket.
3. Fasten each pivot bracket to the rear of the transport using three 10-32 × 3/4 inch long socket-head screws with a no. 10 split washer under each screw head (do not use flat washers). Note orientation of pivot bracket flange shown in Figure 2-7.
4. If slide-rack mount parts are not separated, press release button on side of inner slide member (Figure 2-7), and remove inner slide member from middle slide member.

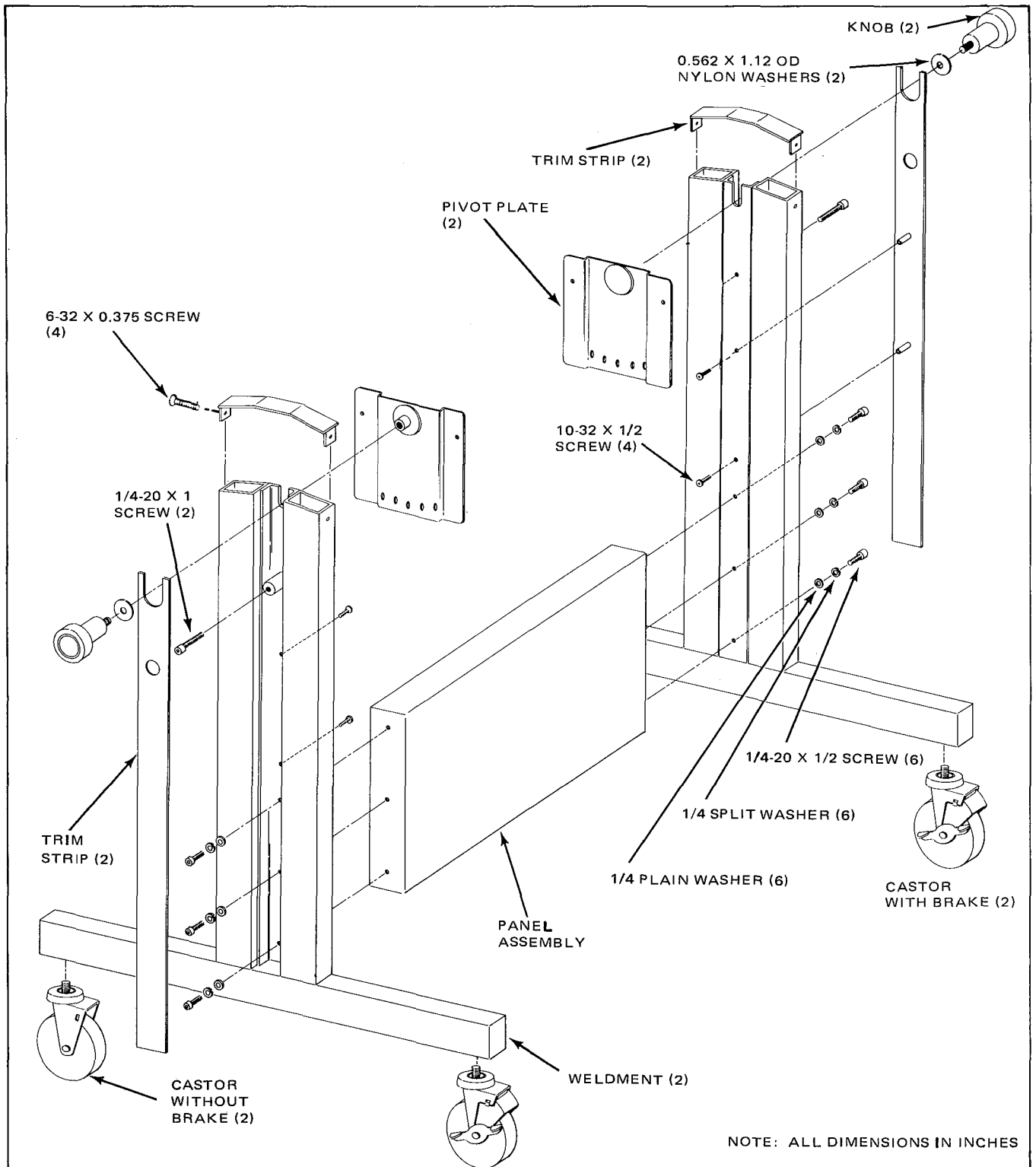

Figure 2-5. Pedestal Assembly, Exploded View

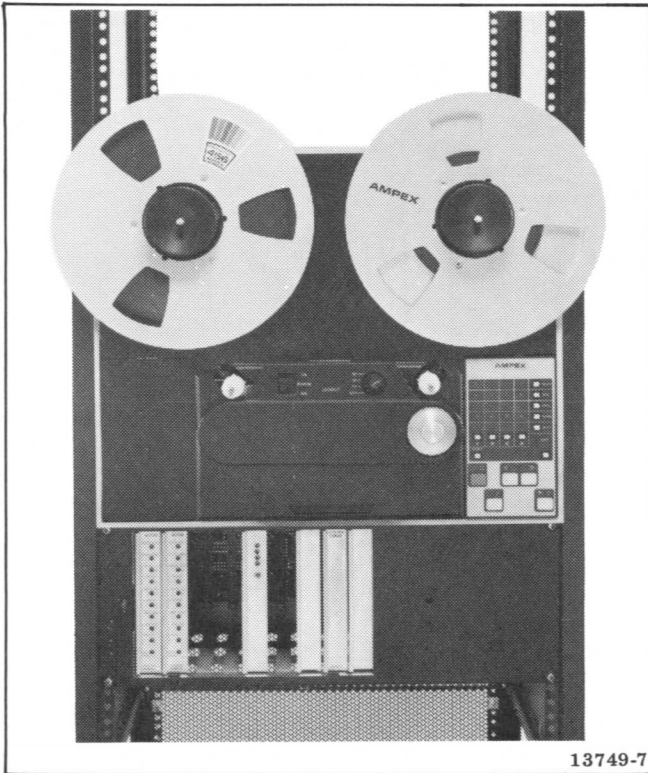

Figure 2-6. Fixed-Rack Mount with Electronics Assembly Cover Panel Removed

5. Attach inner slide member to pivot bracket using two 10-32 × 1/2 inch long flat-head screws and locknuts (nuts have lock washers attached).

NOTE

In the following step, the location of the bar nuts determines the transport vertical position in the 19-inch rack. The transport will extend 4-1/2 inches (11.43 cm) below the lower screw and extend 9-1/2 inches (24.13 cm) above the upper screw.

6. Determine desired vertical mounting location on 19-inch rack. Fasten a threaded bar nut to each front rack-mounting member (Figure 2-9). Orientate the bar nut so that the offset holes in the bar nut are nearest the center of the rack. Use two 10-32 × 1/2 inch long

screws for each bar nut, but do not firmly tighten screws.

7. Mount a threaded bar nut on each rear rack-mounting member (Figure 2-9) in parallel to the bar nuts installed in step 6. Orientate the bar nut so that the offset holes in the bar nut are nearest the center of the rack. Use two 10-32 × 1/2 inch long screws for each bar nut but do not firmly tighten screws.
8. Slide the slotted flange of each outer slide member (Figure 2-7) between the front rack mounting member and the bar nut installed in step 6. Tighten screws.
9. Slide the slotted flange of each rear bracket between the rear rack-mounting member (Figure 2-9) and the bar nut installed in step 7. Tighten screws.
10. Fasten the outer slide member to the rear bracket (as shown in Figure 2-7) using a bar washer, bar nut, and two 10-32 × 1/2 inch long binding-head screws.
11. With two people lifting the transport, insert the inner slide member within the flanges of the middle slide member.
12. Reinstall rear overlay panel removed in step 1.

WARNING

BE CAREFUL NOT TO PINCH FINGERS WHEN SLIDING THE EXTENDED TRANSPORT BACK INTO RACK. ALSO WHEN SLIDES ARE EXTENDED, DO NOT PUSH SLIDE RELEASE BUTTON AND PULL TRANSPORT FORWARD UNLESS IT IS DESIRED TO REMOVE TRANSPORT FROM RACK.

2-8. MOUNTING THE INPUT/OUTPUT MODULE ACCESSORY

Two input/output modules may be mounted side-by-side in an input/output mainframe assembly.

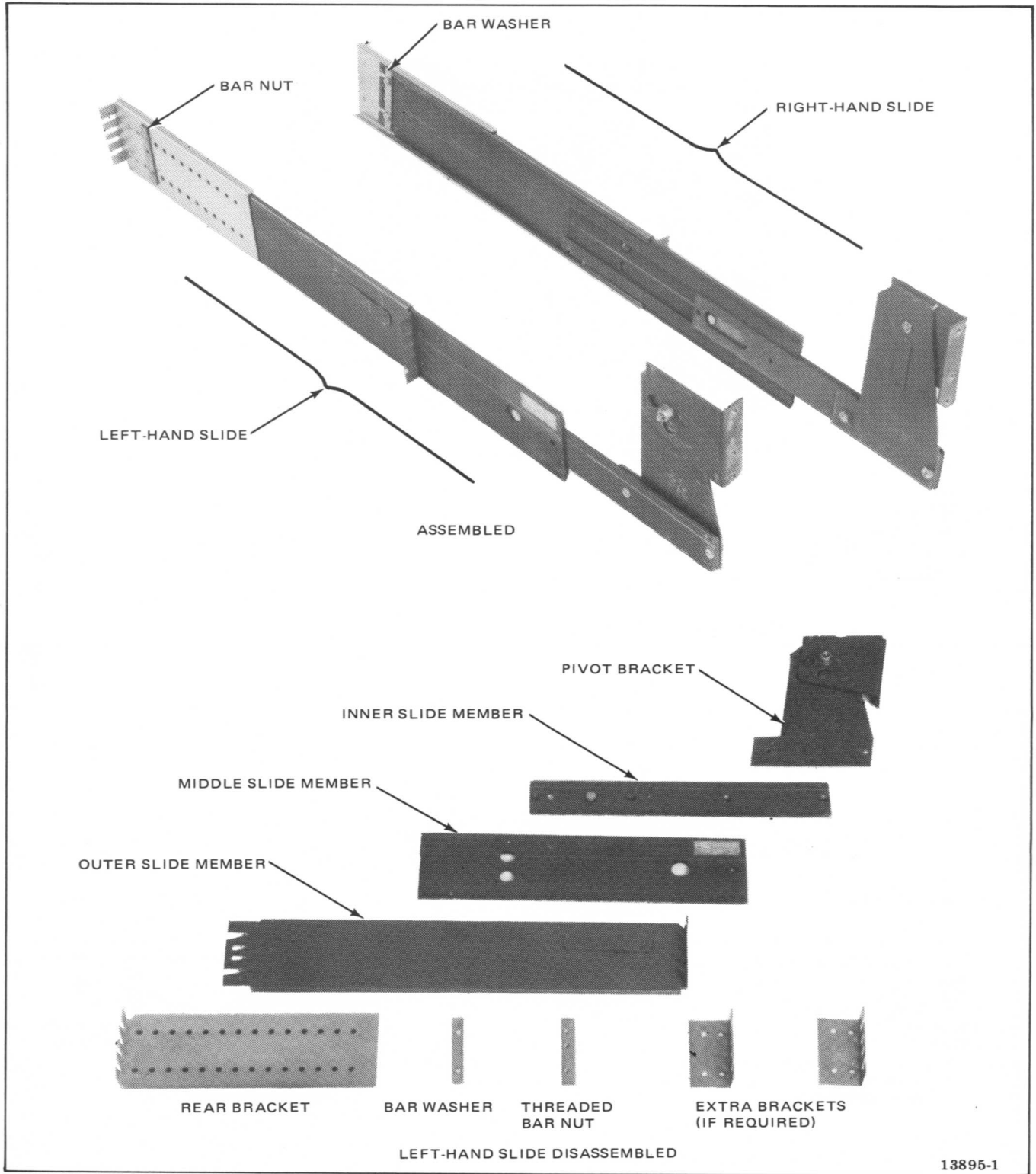

Figure 2-7. Slide Rack Mount Kit

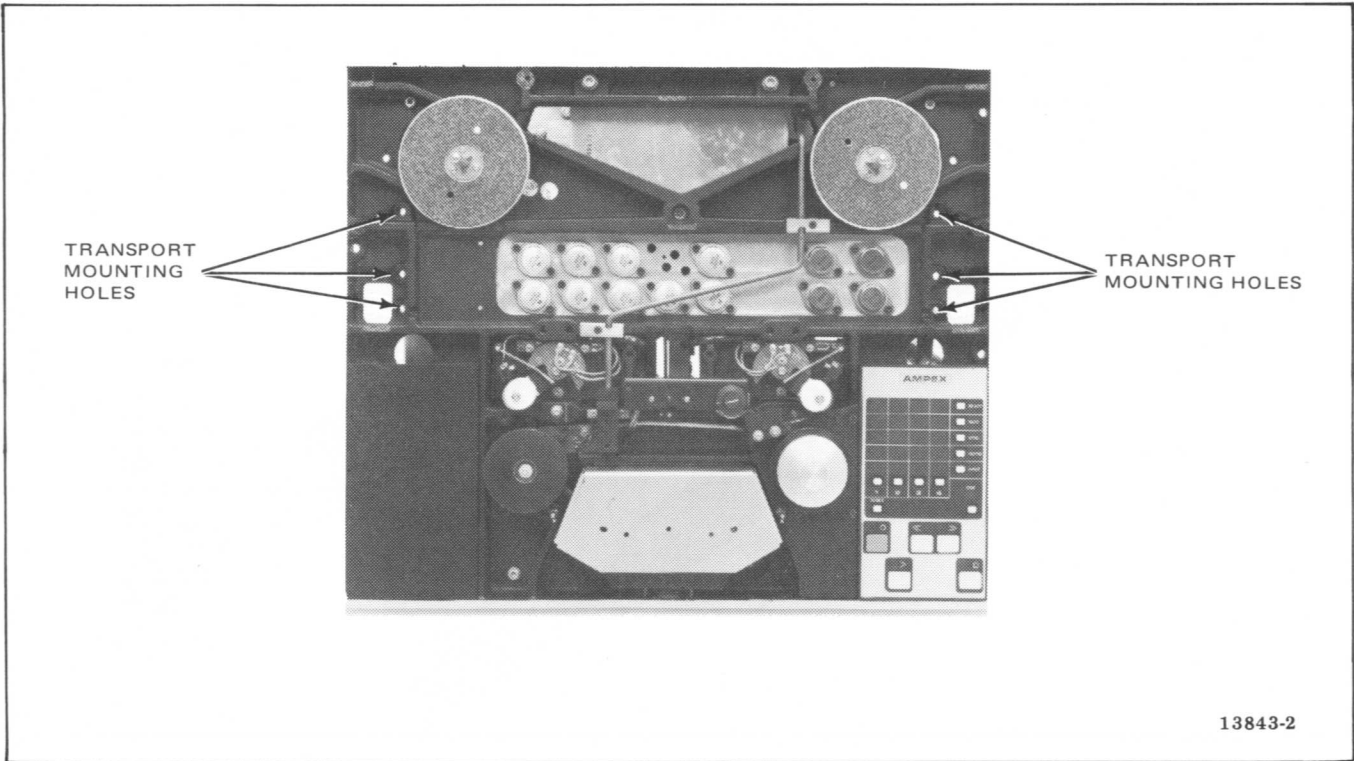

Figure 2-8. Slide-Rack Mount Transport-Mounting Holes

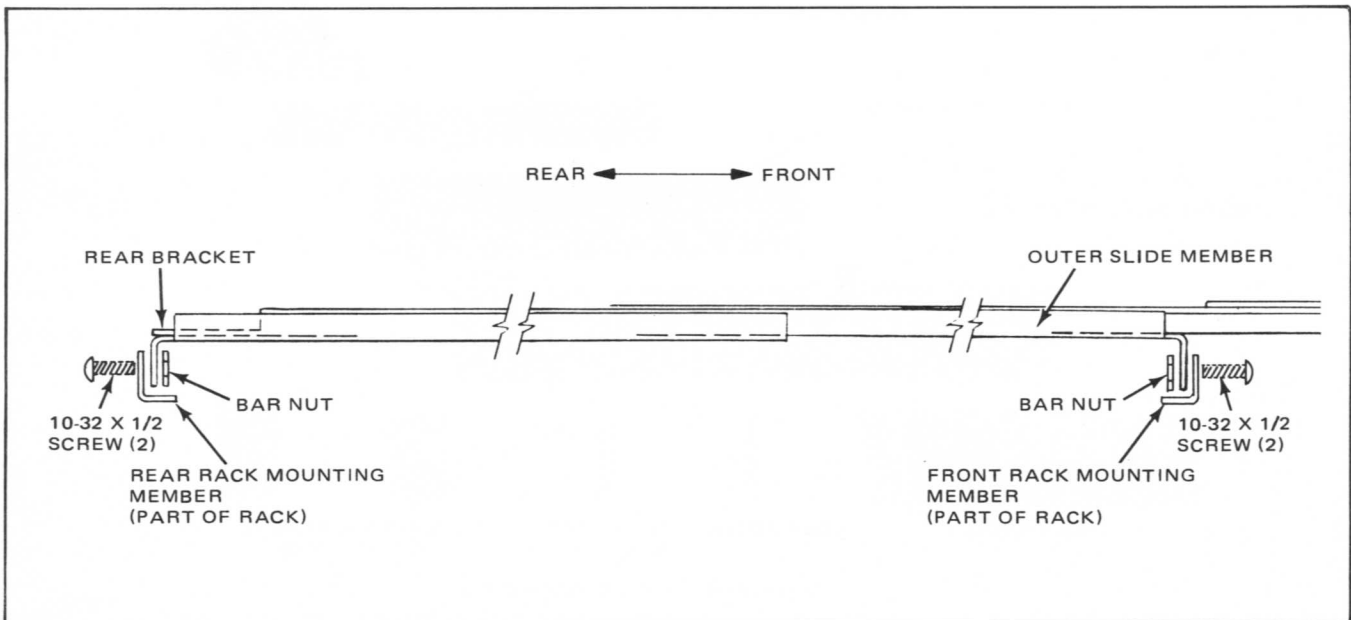

Figure 2-9. Left Hand Slide, Top View

The mainframe assembly may be installed into an enclosure mounted on the recorder/reproducer cabinet, or mounted in a 19-inch (48.26 cm) rack with an accessory top cover. Two mainframes can be mounted vertically to accommodate a four-channel system.

2-9. Cabinet Mount

Proceed as follows:

1. Slide the input/output mainframe assembly into the cabinet enclosure as shown in Figure 2-10.
2. Secure with two 10-32 X 1/2 socket-head screws as shown in Figure 2-10.
3. Slide input/output module(s) into mainframe assembly and secure with captive screw (Figure 2-10).

2-10. Rack Mount

Proceed as follows:

1. Install cover on top of input/output mainframe assembly using nine screws supplied in cover kit (Ampex Part No. 4020428).
2. Mount the input/output mainframe assembly on a standard 19-inch rack or in a custom cabinet using two appropriate-size screws, depending on the type of rack or cabinet.
3. Slide input/output module(s) into mainframe assembly and secure with captive screw(s) shown in Figure 2-10.

2-11. CHECKING CABLES AND COMPONENTS

Connectors on the recorder/reproducer are shown on the electronic wiring diagram 4840422 and on the transport interconnect wiring diagram 4840423. Before attempting to operate the recorder/reproducer, check the following cables and components for security and proper installation. (Note: Connectors that are mounted on a cable or harness are identified as "P". Connectors that are fixed to a chassis are identified as "J".)

1. Control unit connector P11 to electronics assembly connector J11.
2. Reel-drive connector P15 to electronics assembly harness connector P15.
3. Tach sensors connector J16 to electronics assembly harness connector P16.
4. Transport harness connector P1 to J1 on power supply.
5. Transport harness connector P2 to J2 on power supply.
6. Transport harness connector P17 to takeup motor connector P17.
7. Transport harness connector P19 to supply motor connector P19.
8. Transport harness connector P18 to capstan motor connector P18.
9. Fan connector P20 to transport harness connector P20 (if applicable).

2-12. CONNECTING AC POWER

Main ac power is connected to the recorder/reproducer through a captive power cable equipped with a standard 120-volt 3-pin connector. The captive power cable is attached to a power switch bracket mounted on the power supply (Figure 2-11). The main power transformer has various taps that permit the recorder/reproducer to use one of four input voltage ranges: 90-115, 110-135, 180-230, and 220-270 Vac, 50 or 60 Hz.

A jumper plug and socket arrangement (Figure 2-12) accessible inside the power supply, adapts the recorder/reproducer for the various input voltages. The jumpers are factory-set to 110-135 Vac unless specified otherwise on the sales order. However, the line voltage should be measured and, if required, the jumpers reset to correspond to the line voltage. Table 2-1 lists the various voltages and the corresponding jumper-plug position.

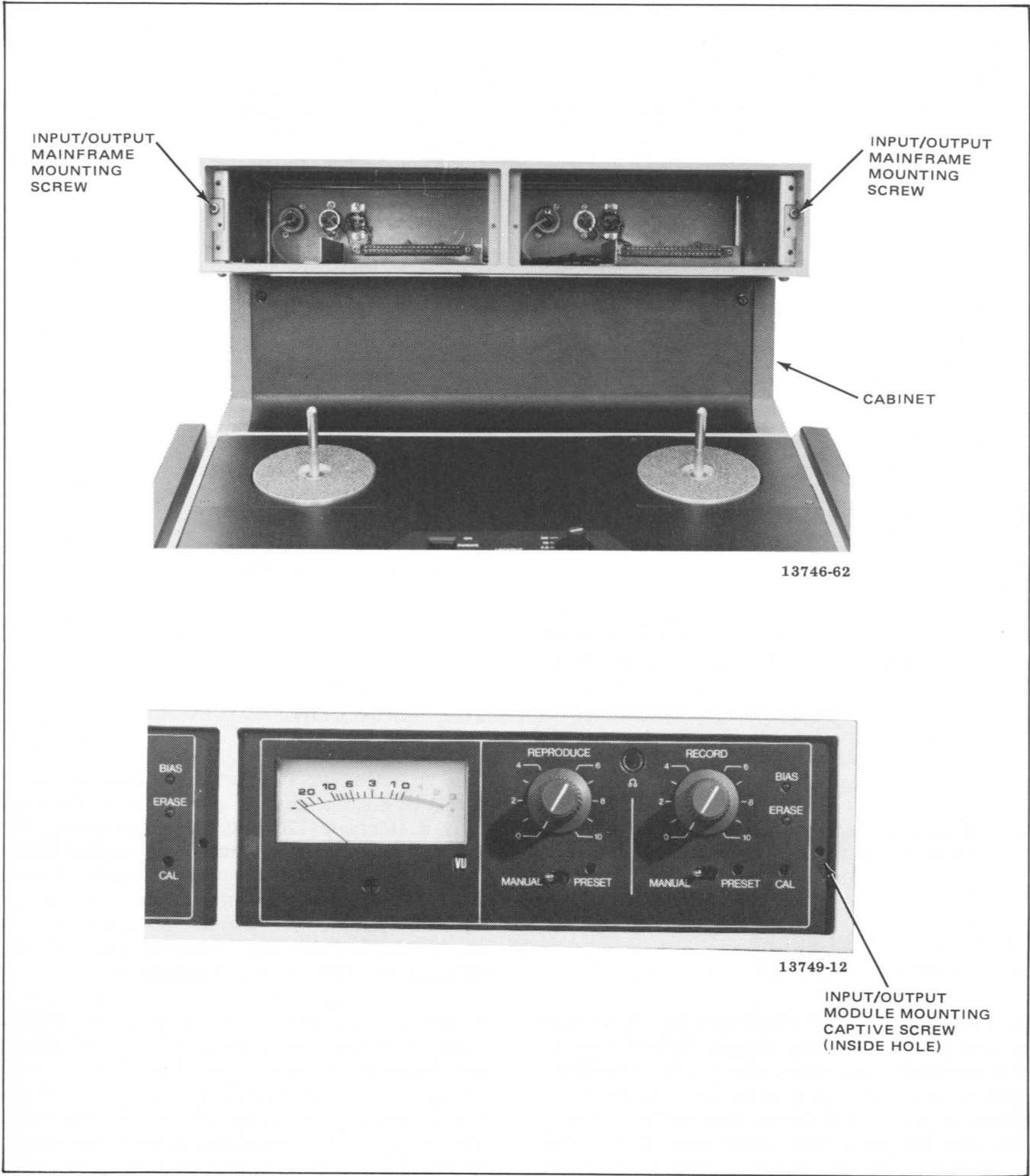

Figure 2-10. Input/Output Assembly Mounting

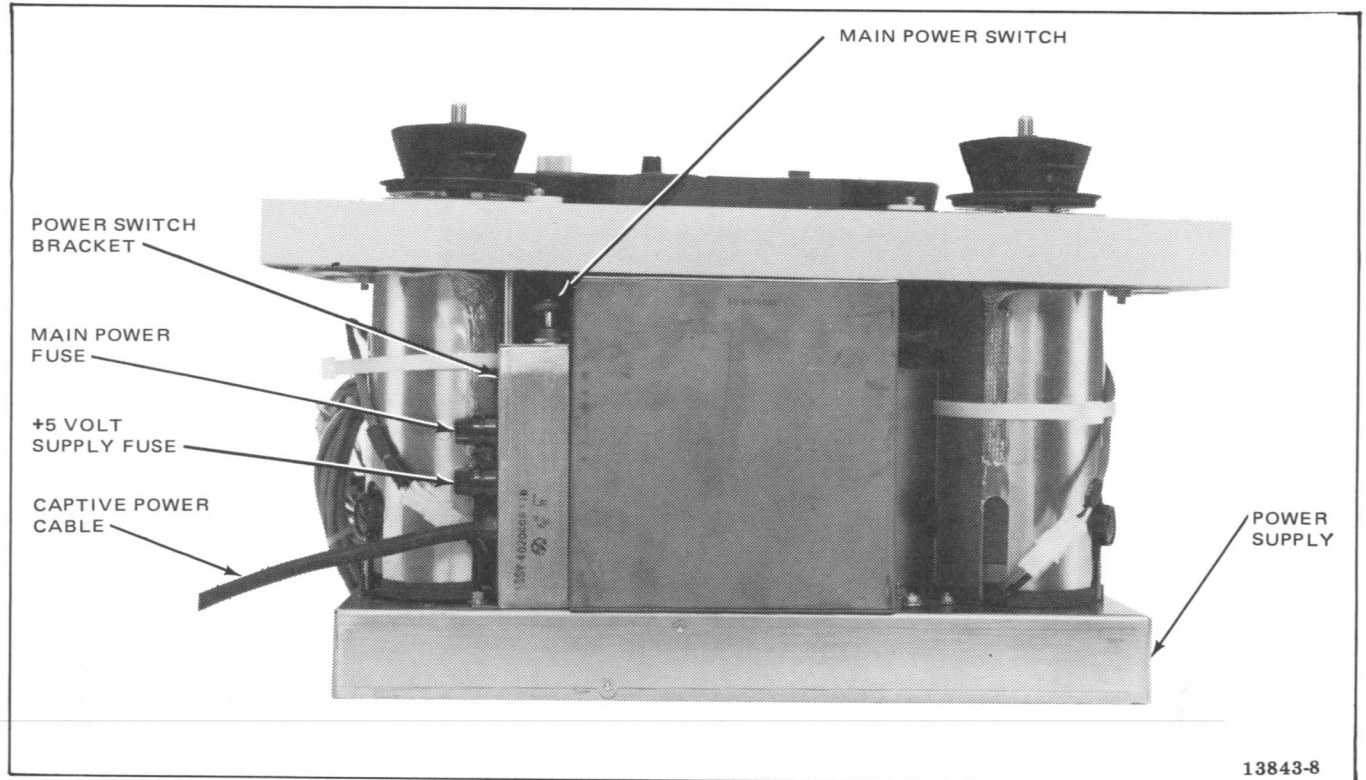

Figure 2-11. Recorder/Reproducer, Rear View

To change jumper plug positions, proceed as follows:

1. At the bottom side of the recorder/reproducer, loosen the four power supply cover screws and remove the cover to gain access to the power jumper socket (Figure 2-12).

CAUTION

WHEN INSTALLING POWER JUMPERS, MAKE CERTAIN THAT THE 3-PIN POWER JUMPER DOES NOT MATE WITH PIN LOCATIONS 1, 2, OR 3 ON JUMPER SOCKET. ONLY THE 4-PIN POWER JUMPER MATES WITH PIN LOCATIONS 1, 2 OR 3.

2. Refer to Table 2-1 and install the three- and four-pin jumper plugs corresponding to the supplied ac line voltage. Note that both jumper plugs are installed vertically in column A, B, or C.

3. Replace power supply cover and secure with four screws.

2-13. AUDIO SIGNAL CONNECTIONS

Audio signal input and output connectors are located on the basic recorder/reproducer and on the input/output assembly (accessory). All audio signal input and output connections to the basic recorder/reproducer are unbalanced line. If an input/output assembly is being used, the audio signal input and output connections may be either balanced or unbalanced line. Audio signal input and output connector wiring instructions for the basic recorder/reproducer and for the input/output assembly are given in the test that follows.

2-14. Recorder/Reproducer Input/Output Connectors

The audio signal input and output connectors (J13 and J14) on the recorder/reproducer are

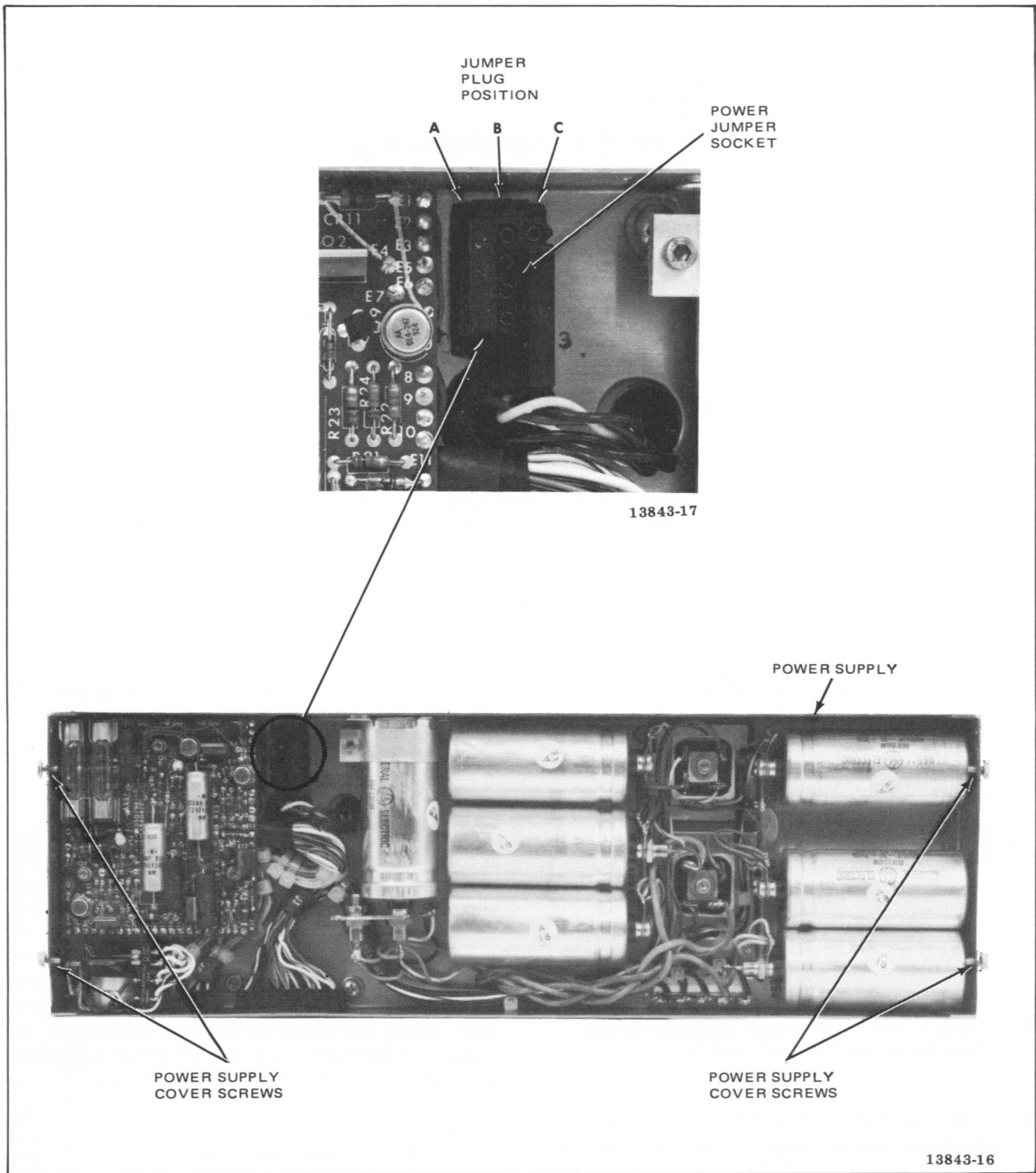

Figure 2-12. Main Power Jumper Location

Table 2-1. Power Jumper Positions

AC LINE VOLTAGE	JUMPER/COLUMN POSITION		
	A	B	C
90-115	4 PIN	3 PIN	
110-135	4 PIN		3 PIN
180-230	3 PIN	4 PIN	
220-270	3 PIN		4 PIN

COLUMN/PIN NUMBERS

A	B	C
3	2	1
6	5	4
9	8	7
12	11	10

POWER JUMPER SOCKET

located at the bottom of the electronics assembly (Figure 2-13). All signal input and output connections for channels 1 and 2 are made to J13, and connections for channels 3 and 4 are made to J14. Use 24-pin Amphenol connectors (Ampex Part No. 139-840) furnished with the recorder/reproducer. Tables 2-2 and 2-3 provide a description of all the connector pin signals. All audio signal input and output connections are wired for unbalanced line. (For balanced input, see wiring instructions in paragraph 2-17.)

2-15. Input-Connector Wiring. Use single-conductor shielded cable. Wire connectors J13 and J14 as follows:

- Channel 1 – connect center conductor to pin 1 and shield to pin 13 of J13.
- Channel 2 – connect center conductor to pin 2 and shield to pin 14 of J13.
- Channel 3 – connect center conductor to pin 1 and shield to pin 13 of J14.

Channel 4 – connect center conductor to pin 2 and shield to pin 14 of J14.

2-16. Output-Connector Wiring. Use single-conductor shielded cable. Wire connectors J13 and J14 as follows:

- Channel 1 – connect center conductor to pin 11 and shield to pin 23 of J13.
- Channel 2 – connect center conductor to pin 12 and shield to pin 24 of J13.
- Channel 3 – connect center conductor to pin 11 and shield to pin 23 of J14.
- Channel 4 – connect center conductor to pin 12 and shield to pin 24 of J14.

2-17. Input/Output Assembly Connectors

The audio signal input and output connectors (J1 through J4) on the input/output assembly are located at the rear of the input/output assembly (Figure 2-14). These connectors permit either balanced or unbalanced line inputs and outputs of the recorder/reproducer depending how the connectors are wired. The connectors are standard three-conductor XLR type. Female contact connectors are used for the input signals and male contact connectors are used for output signals. The mating connectors are supplied with the input/output assembly.

The input/output assembly is connected to the recorder/reproducer by means of a captive cable attached to the input/output assembly. Connect this cable to J13 for channels 1 and 2, and to J14 for channels 3 and 4. To wire the mating plugs, refer to Figure 2-15 and proceed as follows.

2-18. Input-Connector Wiring. For balanced inputs, wire male contact XLR connector as follows:

1. Connect signal leads of two-conductor shielded cable to pin 3 (high) and pin 2 (low) of connector.
2. Connect cable shield to pin 1.

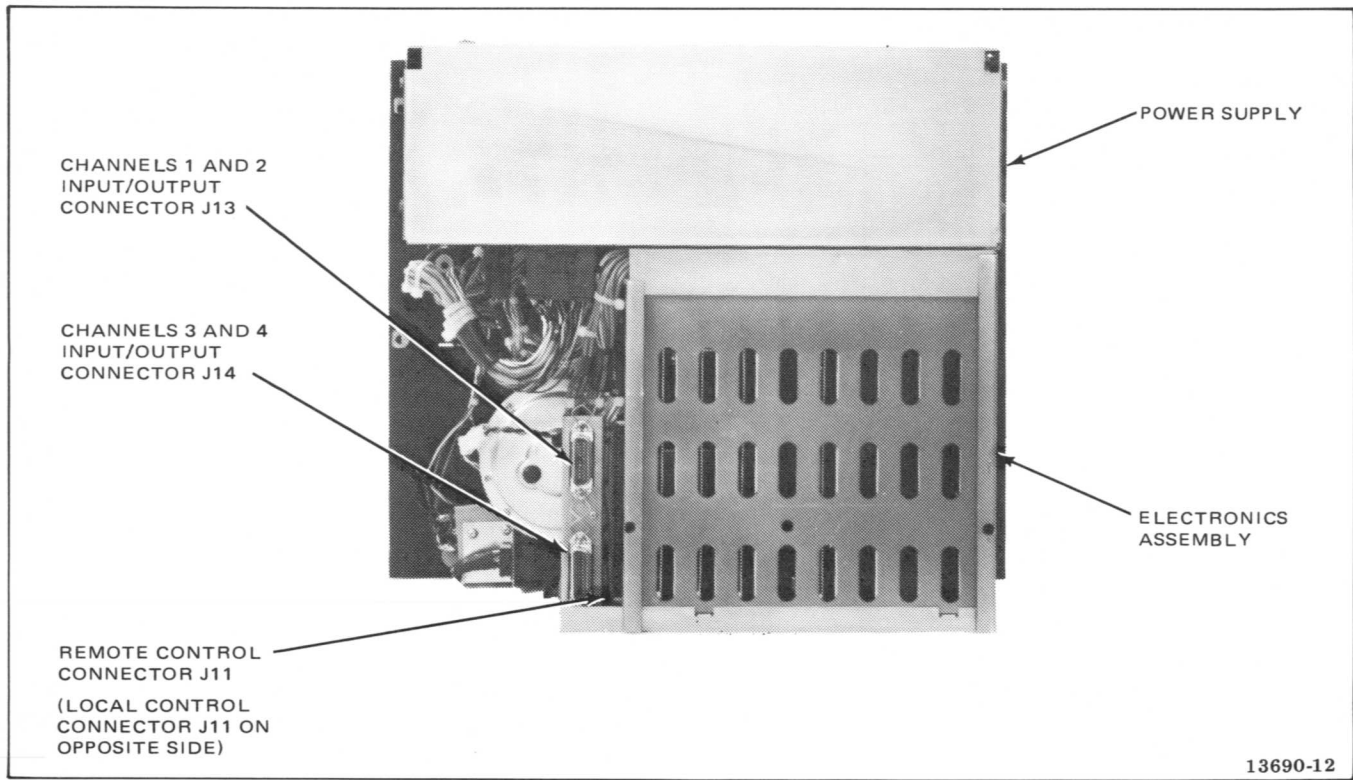

Figure 2-13. Connector Locations, Bottom View of Recorder/Reproducer

For unbalanced inputs, wire male contact XLR connector as follows:

1. Connect center conductor of single-conductor shielded cable to pin 3 of connector.
2. Connect cable shield to pins 2 and 1.

2-19. Output-Connector Wiring. For balanced outputs, wire female contact XLR connector as follows:

1. Connect signal leads of two-conductor shielded cable to pin 3 (high) and pin 2 (low) of connector.
2. Connect cable shield to pin 1.

For unbalanced outputs using two-conductor shielded cable, wire female contact XLR connector as follows:

1. Connect signal leads of cable to pin 3 (high) and pin 2 (low) of connector.
2. Connect cable shield to pin 1 of connector.
3. Connect jumper from pin 1 to pin 2 of connector.

For unbalanced outputs using single-conductor shielded cable, wire female contact XLR connector as follows:

1. Connect center conductor cable to pin 3 of connector.
2. Connect cable shield to pin 2 of connector.
3. Connect jumper between pins 1 and 2 of connector.

Table 2-2. Connector J13 Channel/Signal Identification, Channels 1 and 2

J13 CONNECTOR PINS	CHANNEL	SIGNAL
1	1	Audio input center conductor
2	2	Audio input center conductor
3	—	Chassis ground
4	1	Bias voltage status (BVS)
5	2	Bias voltage status (BVS)
6	1	Erase voltage status (EVS)
7	2	Erase voltage status (EVS)
8	1	Unequalized Sel-Sync output
9	2	Unequalized Sel-Sync output
10	—	Chassis ground
11	1	Audio output center conductor
12	2	Audio output center conductor
13	1	Audio input shield
14	2	Audio input shield
15	—	Chassis ground
16	1 and 2	+22 Vdc
17	1 and 2	Audio power ground
18	1 and 2	-22 Vdc
19	1	TAPE/TAPE
20	1	Unequalized Sel-Sync output ground
21	2	Unequalized Sel-Sync output ground
22	2	TAPE/TAPE
23	1	Audio output shield
24	2	Audio output shield

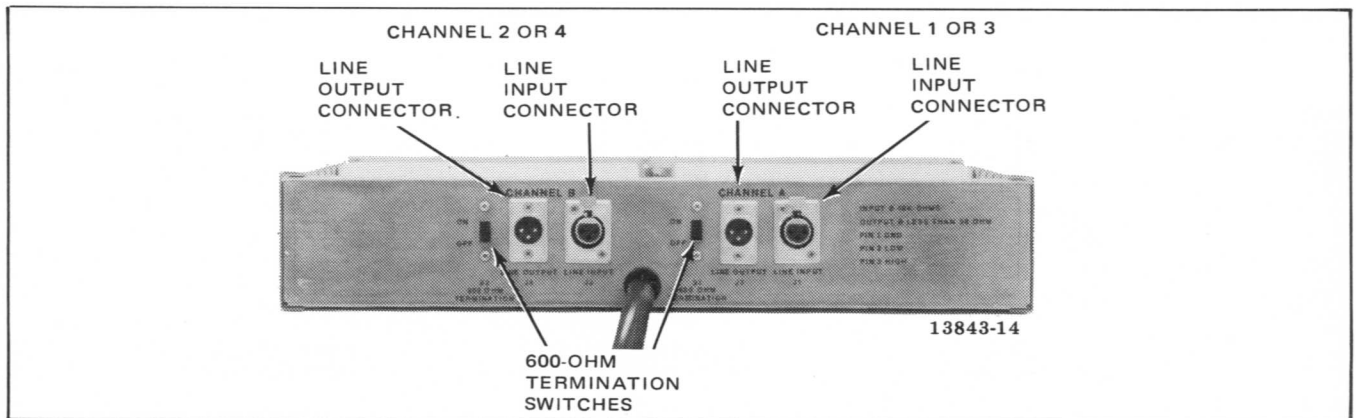

Figure 2-14. Input/Output Assembly, Rear View

Table 2-3. Connector J14 Channel/Signal Identification, Channels 3 and 4

J13 CONNECTOR PINS	CHANNEL	SIGNAL
1	3	Audio input center conductor
2	4	Audio input center conductor
3	—	Chassis ground
4	3	Bias voltage status (BVS)
5	4	Bias voltage status (BVS)
6	3	Erase voltage status (EVS)
7	4	Erase voltage status (EVS)
8	3	Unequalized Sel-Sync output
9	4	Unequalized Sel-Sync output
10	—	Chassis ground
11	3	Audio output center conductor
12	4	Audio output center conductor
13	3	Audio input shield
14	4	Audio input shield
15	—	Chassis ground
16	3 and 4	+22 Vdc
17	3 and 4	Audio power ground
18	3 and 4	-22 Vdc
19	3	TAPE/TAPE
20	3	Unequalized Sel-Sync output ground
21	4	Unequalized Sel-Sync output ground
22	4	TAPE/TAPE
23	3	Audio output shield
24	4	Audio output shield

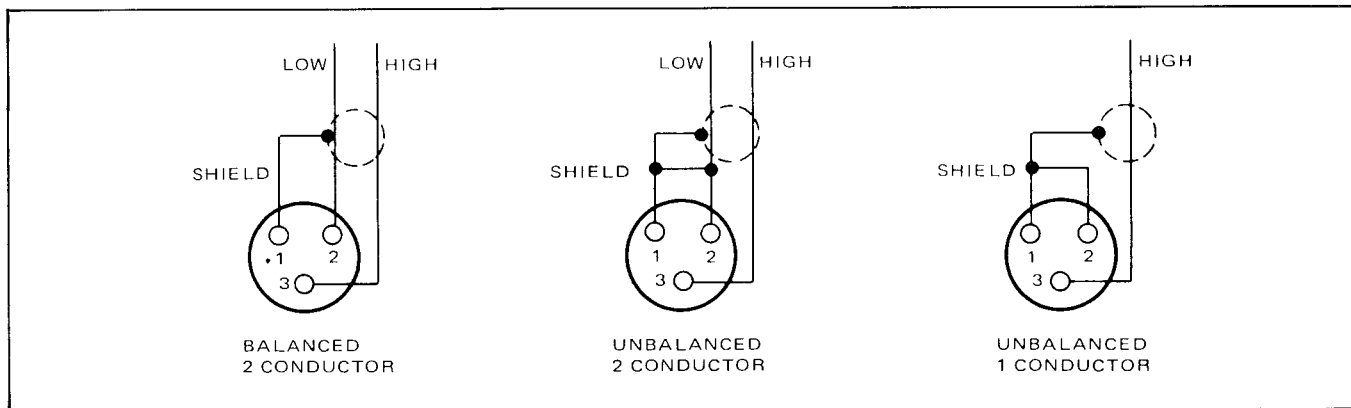

Figure 2-15. Input/Output Assembly Connector Wiring

2-20. REMOTE CONTROL UNIT INSTALLATION

Except for initiating play/edit and stop/edit (unthread) modes, all operational modes of the recorder/reproducer can be controlled from a remote location with an accessory remote control unit (Ampex Part No. 4010264-02). Except for these two modes of operation, the remote control unit operates in parallel with the local control unit at all times. The remote control unit is equipped with a 25-foot captive cable and connector for connection to the recorder/reproducer.

To connect the remote control unit to the recorder/reproducer, proceed as follows:

1. Remove system power.
2. At the bottom side of the recorder/reproducer, locate double-sided connector J11 shown in Figure 2-13. (The local control unit connects to the other side of J11).
3. Plug remote control connector into J11 with the same lead direction as the local control connector and cable dressed out the rear of the transport. No adjustments are required after installing the remote control unit.

2-21. INITIAL ADJUSTMENTS

2-22. Turntable Positioning for Reel Size

The supply and takeup motor assemblies, including turntables, are secured to the transport casting by four hex-head screws. Figure 2-16 shows the supply motor installed in the inner position to accommodate reels up to 11-1/2 (29.21 cm) inches in diameter and in the outer position to accommodate reels larger than 11-1/2 inches in diameter. Separate motor-mounting holes are used to mount the motor in the inner or outer position. No recorder/reproducer electrical adjustments are required when the motor is changed from one position to the other. To relocate the motor assembly to accommodate large reels, proceed as follows:

NOTE

When the supply and takeup motor assemblies are positioned to accommodate reels larger than 11-1/2 inches, transports cannot be mounted side-by-side on standard 19-inch racks, because the reels protrude beyond the edges of the racks.

1. At the top of the transport, remove the rear overlay panel (six screws) shown in Figure 2-2.
2. Loosen the two hex-head screws (Figure 2-17) that clamp the turntable to the motor shaft, and remove turntable from shaft.
3. Remove motor shield ground strap (Figures 2-16 and 2-18) from transport.
4. Remove the four motor-mounting hex-head screws shown in Figure 2-16.
5. Loosen, but do not remove, the three power supply screws (Figure 5-45) to permit clearance between the power supply and motor shields.
6. Relocate the motor and the shield end plate to the outer position of the transport with the ground strap facing inward (180° from its previous position, shown in Figure 2-18).
7. Reinstall screws removed in step 4 to secure the motor in the outer position as shown in Figure 2-16.
8. Install motor shield ground strap to transport.
9. Tighten power supply screws loosened in step 5.
10. When each turntable is reinstalled on the motor shaft, it is necessary to establish turntable height by setting the turntable clamp approximately 9 mils (0.229 mm) above the surface of the motor.

MOTOR SHIELD
MOUNTING SCREW

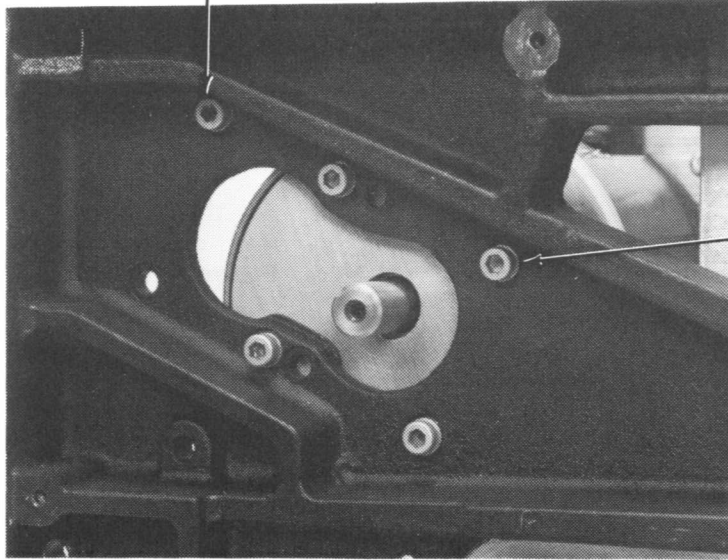

MOTOR MOUNTING
SCREWS (4)

13843-13

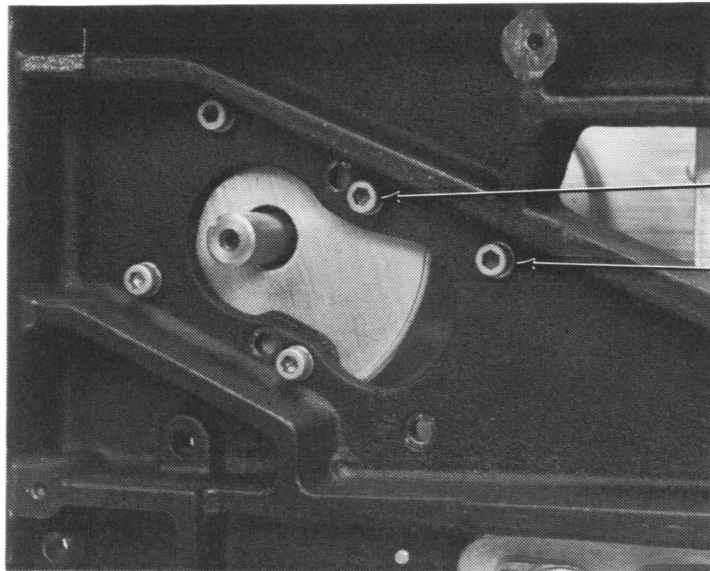

MOTOR MOUNTING
SCREWS (4)

MOTOR SHIELD
MOUNTING
SCREW

13843-12

Figure 2-16. Supply Motor Mounting

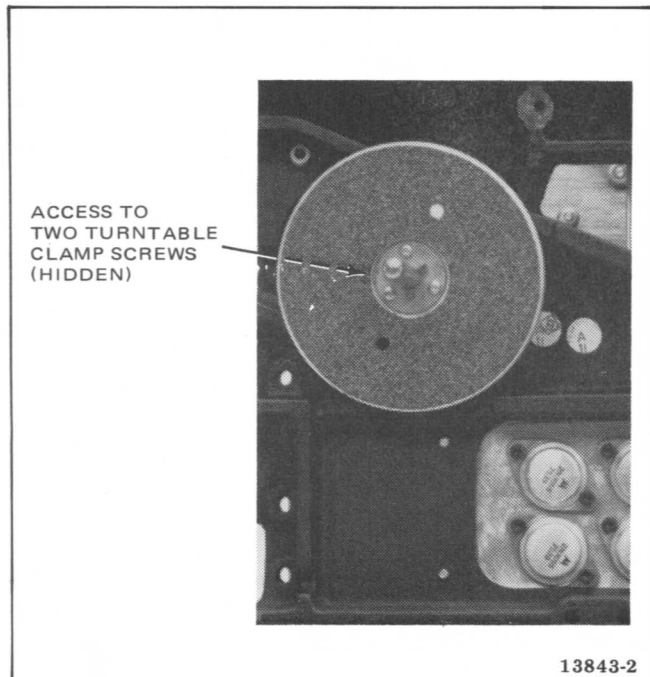

Figure 2-17. Supply Turntable

Proceed as follows:

- a. Place a 0.009-inch (9-mil) thick shim or two strips of paper (each approximately the same thickness as this manual page) on the top surface of the end shield plate to serve as a shim.
 - b. Install the turntable clamp on to the shaft and lower the clamp until contact with the shim is made.
 - c. Tighten the two clamp hex-head screws.
 - d. Remove the shim. Turntable must turn freely without rubbing on motor housing.
11. Reverse the position of each corner overlay attached to the rear overlay panel (Figure 2-2) as follows:
 - a. Remove a single locknut that secures each corner overlay to the rear overlay panel.
 - b. Rotate the corner overlay 180° and re-install locknut.
 12. Reinstall rear overlay panel (six screws) to the transport.

2-23. Control Unit Relocation

For operator convenience, the control unit (Figure 2-19) may be relocated from the right-hand position on the top of the transport to the left-hand position. To relocate the control unit, it is also necessary to remove the electronics chassis from the transport to gain access to the screws that secure the filler panel shown in Figure 2-20. Proceed as follows:

1. Remove system power.
2. Unplug control unit PCB connector P11 from the electronics assembly double-sided connector J11 (Figure 2-13).
3. From the bottom of the transport, remove four flat-head screws that secure the control unit to the transport casting.
4. Free the control unit from the right side of the transport by carefully feeding the control unit captive cable and connector P11 through the hole in the transport.
5. Remove the electronics assembly from the transport as follows:
 - a. Remove head cover, head assembly, and the front overlay panel (two screws).
 - b. Remove ground strap, which connects to electronics assembly, from the tape transport.
 - c. Disconnect electronics assembly harness connector P16 that connects to tach sensor connector J16.
 - d. Disconnect electronic assembly harness connector P16 that connects to tach sensor connector J16.
 - e. Disconnect electronic assembly harness connector P15 that connects to reel drive connector P15.
 - f. From the bottom of the transport, lift and move the electronics assembly to the left of the transport.

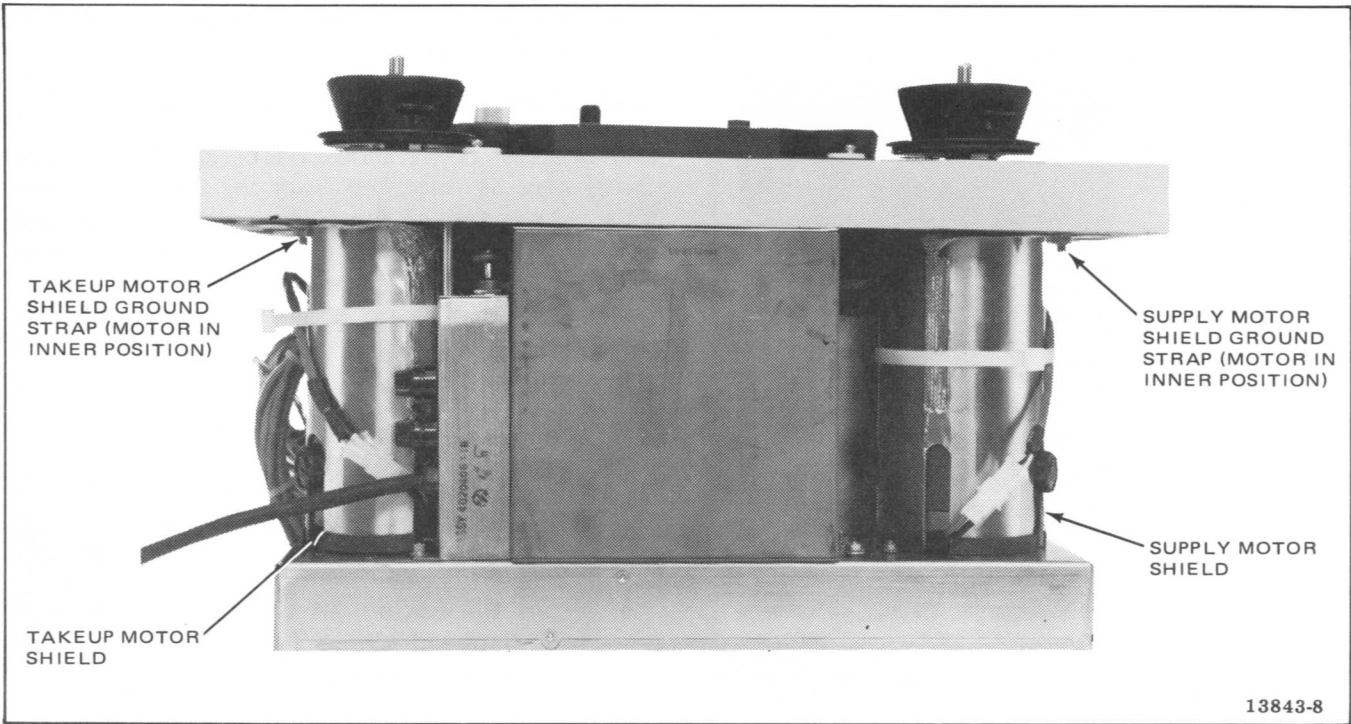

Figure 2-18. Rear View of Transport

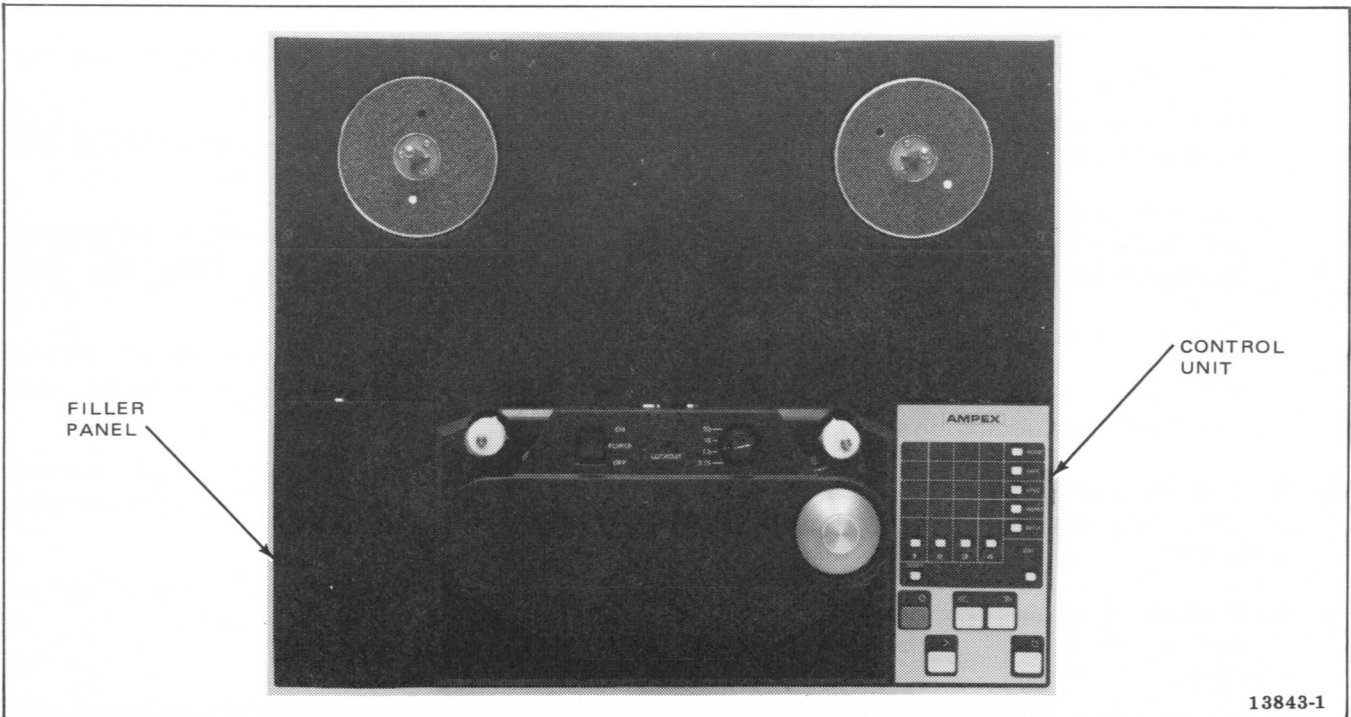

Figure 2-19. Tape Transport

6. Remove left-hand filler panel by removing four flat-head screws accessible from the bottom of the transport casting (Figure 2-20).
7. Feed control unit captive cable connector P11 through hole in the left side of the transport (Figure 2-20) and mount control unit using screws removed in step 3.
8. Route control unit cable connector P11 through the area of the power transistor sockets and leave in this location temporarily.
9. Reinstall electronics assembly in the reverse order of removal (step 5), being careful not to pinch or damage any cables.
10. Plug control unit connector P11 into electronics unit double-sided connector J11.
11. Install filler panel in right-hand position using hardware removed in step 6. Screw down filler panel to bring it even with the transport overlay and outer frame (height is adjustable).

2-24. Spool-Speed Selection

The spool mode speed (60 in/s or 180 in/s) is selected by placement of a solder-in jumper located on the capstan servo PWA. (Machines shipped from the factory are set for 180-in/s operation.) To change spool mode speed, refer to Figure 2-21 and proceed as follows:

1. With power off, remove capstan servo PWA No. 8 from the electronics assembly.
2. For 60-in/s operation, install jumper between E2 and E3 and solder in place.
3. For 180-in/s operation, install jumper between E1 and E2 and solder in place.
4. Reinstall capstan servo PWA No. 8 into electronics assembly.

2-25. Play/Edit Mode Lockout

To prevent play/edit mode from being selected from the local control panel, a jumper can be

repositioned on transport control PWA No. 7. (Machines shipped from the factory are set for play/edit mode operation.) To change jumper position, refer to Figure 2-22 and proceed as follows:

1. With power off, remove transport control PWA No. 7 from the electronics assembly.
2. For normal play/edit operation, install jumper between E12 and E13, and solder in place.
3. To prevent play/edit mode from being enabled, install jumper between E13 and E14, and solder in place.
4. Reinstall transport control PWA No. 7 into electronics assembly.

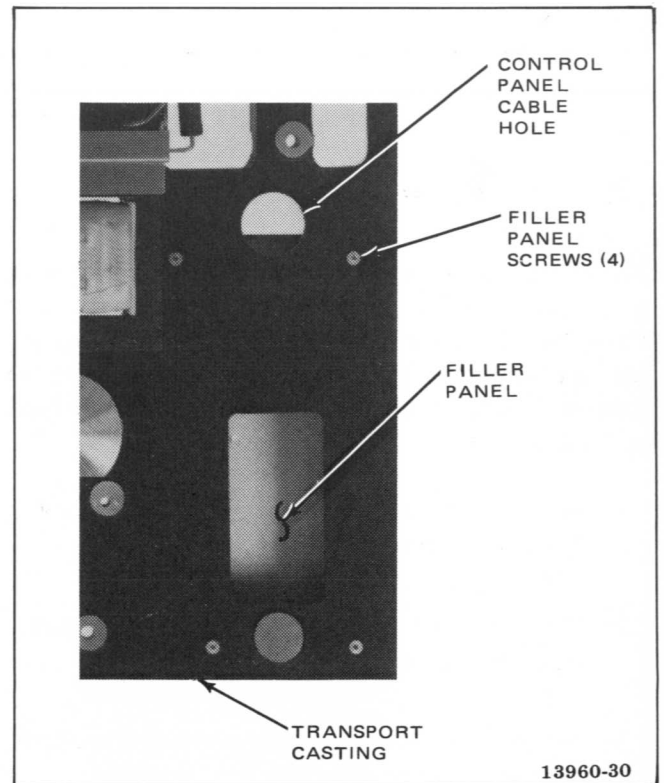

**Figure 2-20. Rear View of Filler Panel
(Transport Components Removed for Clarity)**

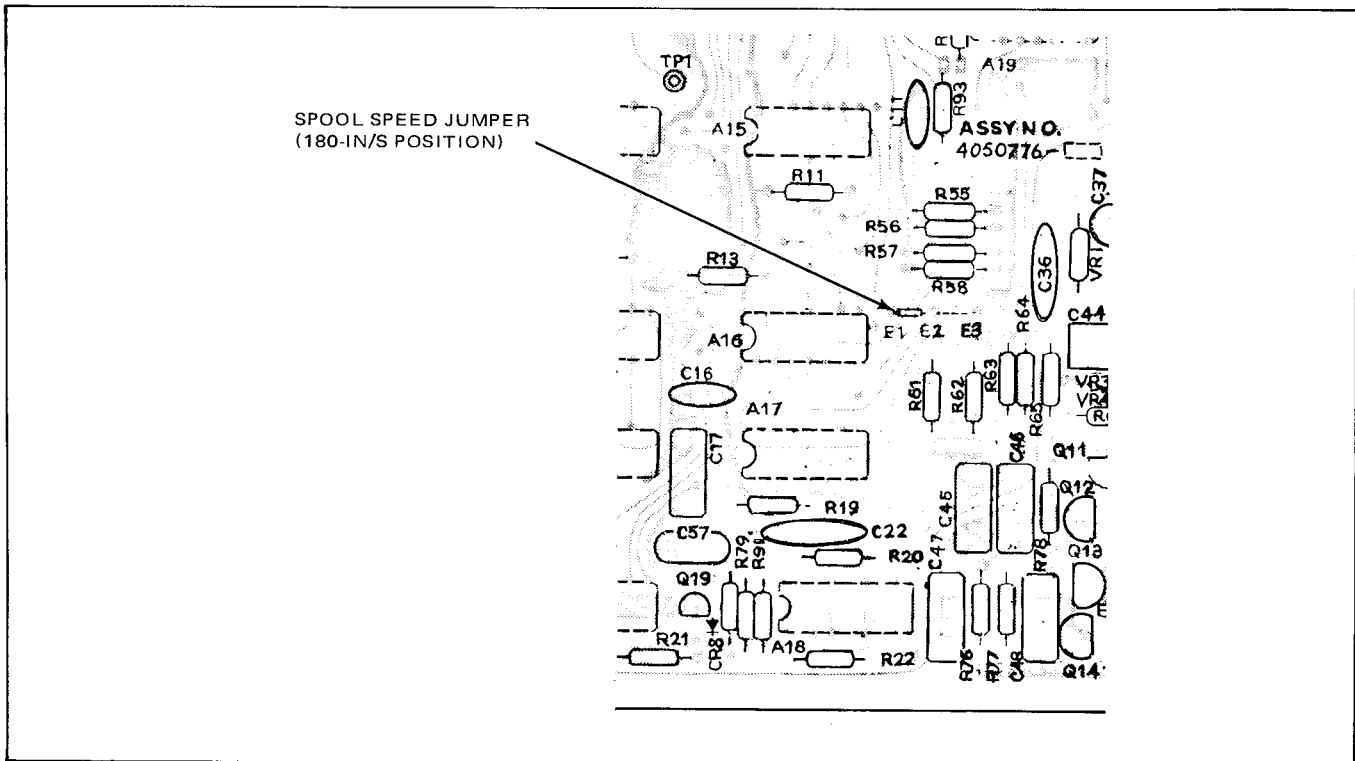

Figure 2-21. Spool Speed Jumper, Capstan Servo PWA No. 8

2-26. Record Mode Lockout

To prevent all channels from entering record mode, a jumper can be repositioned on audio control PWA No. 5. (Machines shipped from the factory are set for record mode operation.) To change jumper position, refer to Figure 2-23 and proceed as follows:

1. With power off, remove audio control PWA No. 5 from the electronics assembly.
2. To enable all channels to enter record mode, position jumper J5 in the REC position.
3. To prevent record mode from being enabled, position jumper J5 in the REC position.
4. Reinstall audio control PWA No. 5 into electronics assembly.

2-27. Tape Timer Display Selection

The tape timer can display elapsed time in hours, minutes, and seconds or minutes, seconds and tenths of seconds. (Machines shipped from the factory are set to display hours, minutes and seconds.) To change the display format, jumpers are repositioned on transport control PWA No. 7 and on control unit PWA No. 1.

2-28. Minutes, Seconds, and Tenths of Seconds Display.

To change display to read minutes, seconds, and tenths of seconds, proceed as follows:

1. With power off, remove transport control PWA No. 7 from electronics assembly.
2. Remove existing jumpers and install jumpers between the following terminals (Figure 2-24) and solder in place.

E 1 to E7	E4 to E10
E2 to E8	E5 to E11
E3 to E9	

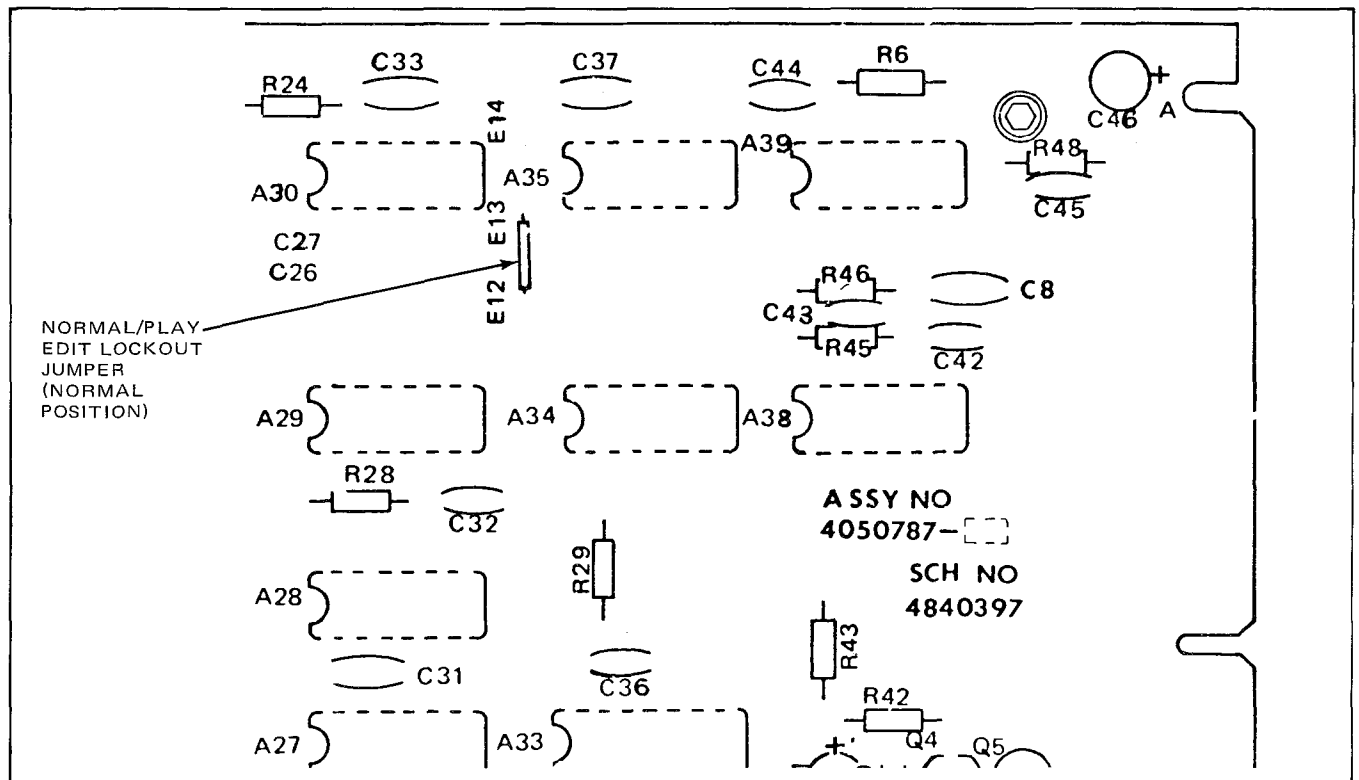

Figure 2-22. Normal/Play Edit-Lockout Jumper, Transport Control PWA No. 7

3. Reinstall transport control PWA No. 7 into electronics assembly.
 4. From the rear of the transport casting, remove four flat-head screws that secure the control unit to the casting, to free the control unit.
 5. Remove the case bottom of the control unit (Figure 2-25).
 6. Remove two screws shown in Figure 2-25 to gain access to six hex spacers shown in Figure 2-26.
 7. Remove the four locking plates (Figure 2-26) that prevent the four outer hex spacers from turning.
 8. Remove the six hex spacers and remove PWA No. 1 from the control unit housing.
 9. Remove jumper on the component side of the board installed between E74 and E76 (Figure 2-27) and install between E74 and E75. Solder in place.
 10. Reassemble control unit in the reverse order of disassembly and reinstall into transport.
- 2-29. Hours, Minutes, and Seconds Display.** To change display to read hours, minutes, and seconds, proceed as follows:
1. With power off, remove transport control PWA No. 7 from the electronics assembly.
 2. Remove existing jumpers and install jumpers between the following terminals (Figure 2-24) and solder in place.

E1 to E6	E4 to E9
E2 to E7	E5 to E10
E3 to E8	

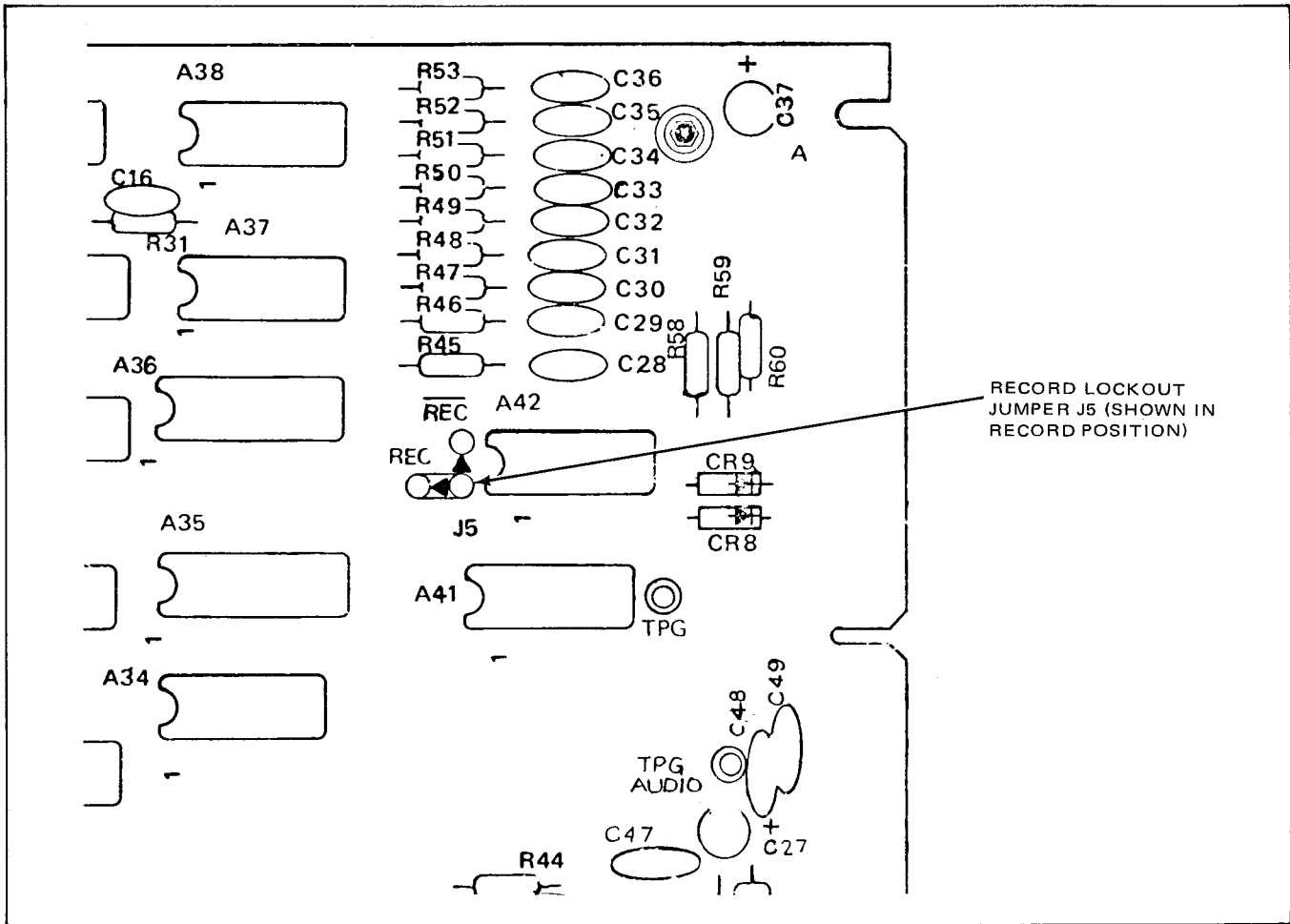

Figure 2-23. Record Lockout Jumper J5, Audio Control PWA No. 5

3. Reinstall transport control PWA No. 7 into electronics assembly.
4. From the rear of the transport casting remove four flat-head screws, that secure the control unit to the casting, to free the control unit.
5. Remove the case bottom of the control unit (Figure 2-25).
6. Remove two screws shown in Figure 2-25 to gain access to six hex spacers shown in Figure 2-26.
7. Remove the four locking plates (Figure 2-26) that prevent the four outer hex spacers from turning.
8. Remove the six hex spacers and remove PWA No. 1 from the control unit housing.
9. Remove jumper on the component side of the board installed between E74 and E75 (Figure 2-27) and install between E74 and E76. Solder in place.
10. Reassemble control unit in the reverse order of disassembly and reinstall into transport.

2-30. PURC Operation Selection

The recorder/reproducer is capable of operating with or without PURC operation as desired by placement of a jumper located on the PADNET PWA. Recorders shipped from the factory are set for normal (non PURC) operation.

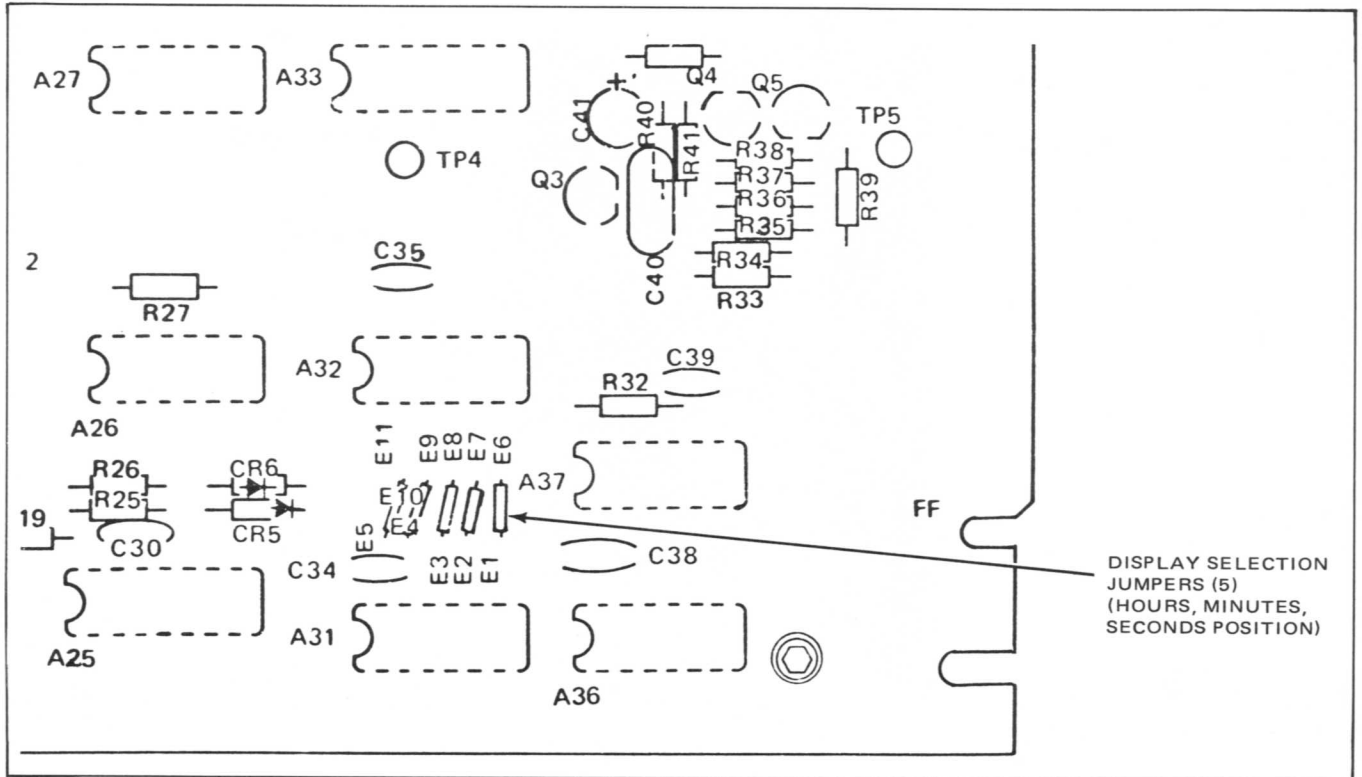

Figure 2-24. Tape Timer Display Selection Jumpers, Transport Control PWA No. 7

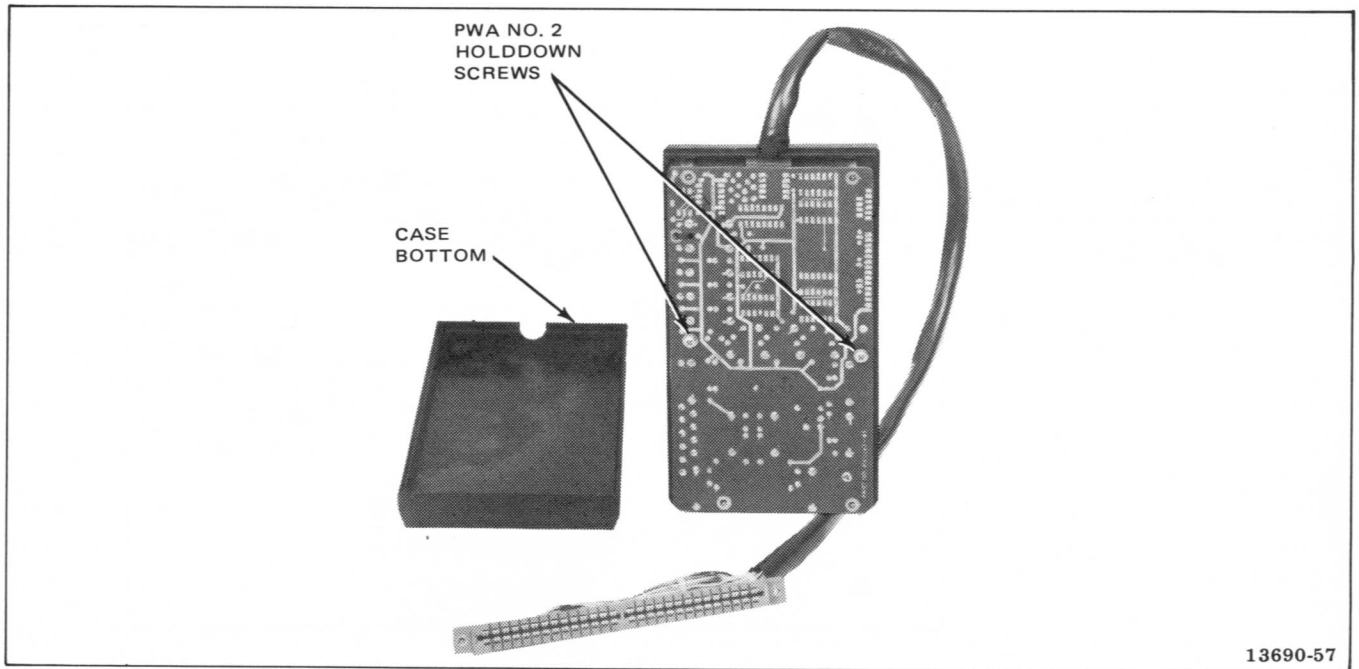

Figure 2-25. Control Unit, Case Bottom Removed

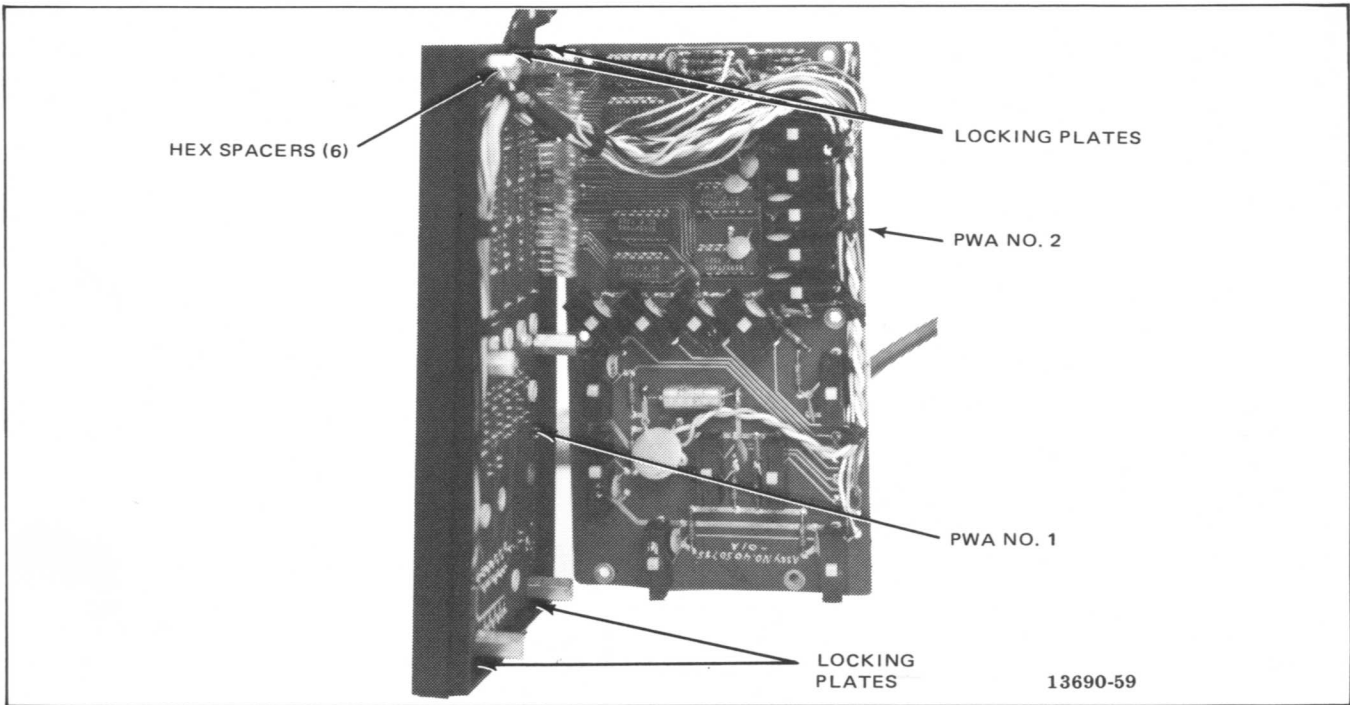

Figure 2-26. Inside View of Control Unit

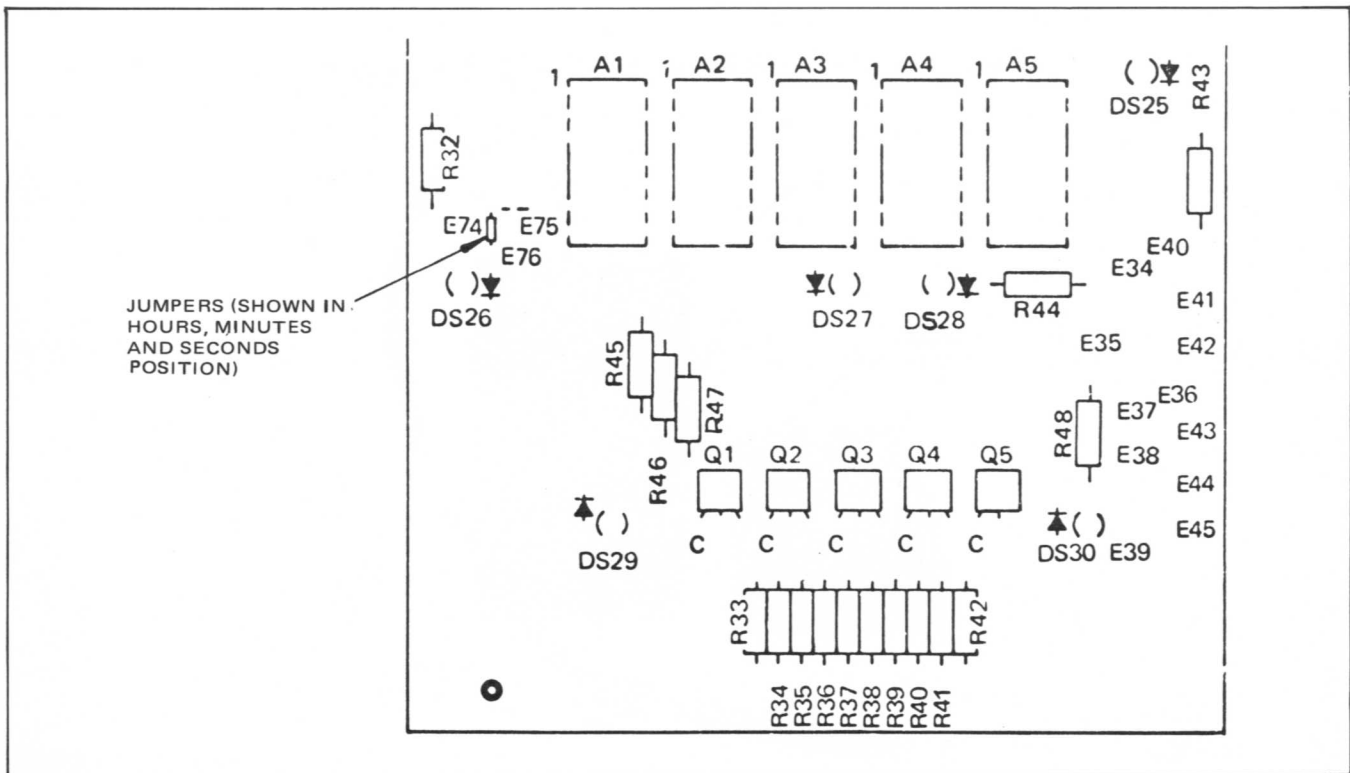

Figure 2-27. Tape Timer Display Selection Jumper, Control Unit PWA No. 1

To select PURC operation, refer to Figure 2-28 and proceed as follows:

1. With power off, remove PADNET PWA from the electronics assembly.
2. Install jumper J3 in the PURC position.
3. Reinstall PADNET PWA into electronics assembly.
4. Repeat steps 1 to 3 for the other channels (if applicable).

2-31. INITIAL CHECKOUT PROCEDURE

Use these instructions to verify that all internal cables have been connected and the system is performing correctly. (Refer to Section 3, Operation for detailed operating instructions as necessary.) Proceed as follows:

1. Connect ac power cord to suitable power source.
2. Set POWER switch to the ON position. All safe and repro indicators should light, the stop and EDIT indicators should light, and the tape timer display should indicate 0 00 00. (Note: the LOCKOUT indicator always lights for 2 to 3 seconds after power is first applied.)
3. Set speed-select rotary switch to desired tape speed. If a speed is selected that the signal system of the recorder/reproducer is not set up for, the LOCKOUT indicator should light.
4. Install a reel of tape on the supply turntable and an empty reel on the takeup turntable.
5. Thread tape on transport (refer to paragraph 3-2) and place recorder/reproducer into thread mode.

CAUTION

BEFORE CONNECTING AC POWER, REFER TO INSTRUCTIONS GIVEN IN PARAGRAPH 2-12, CONNECTING AC POWER.

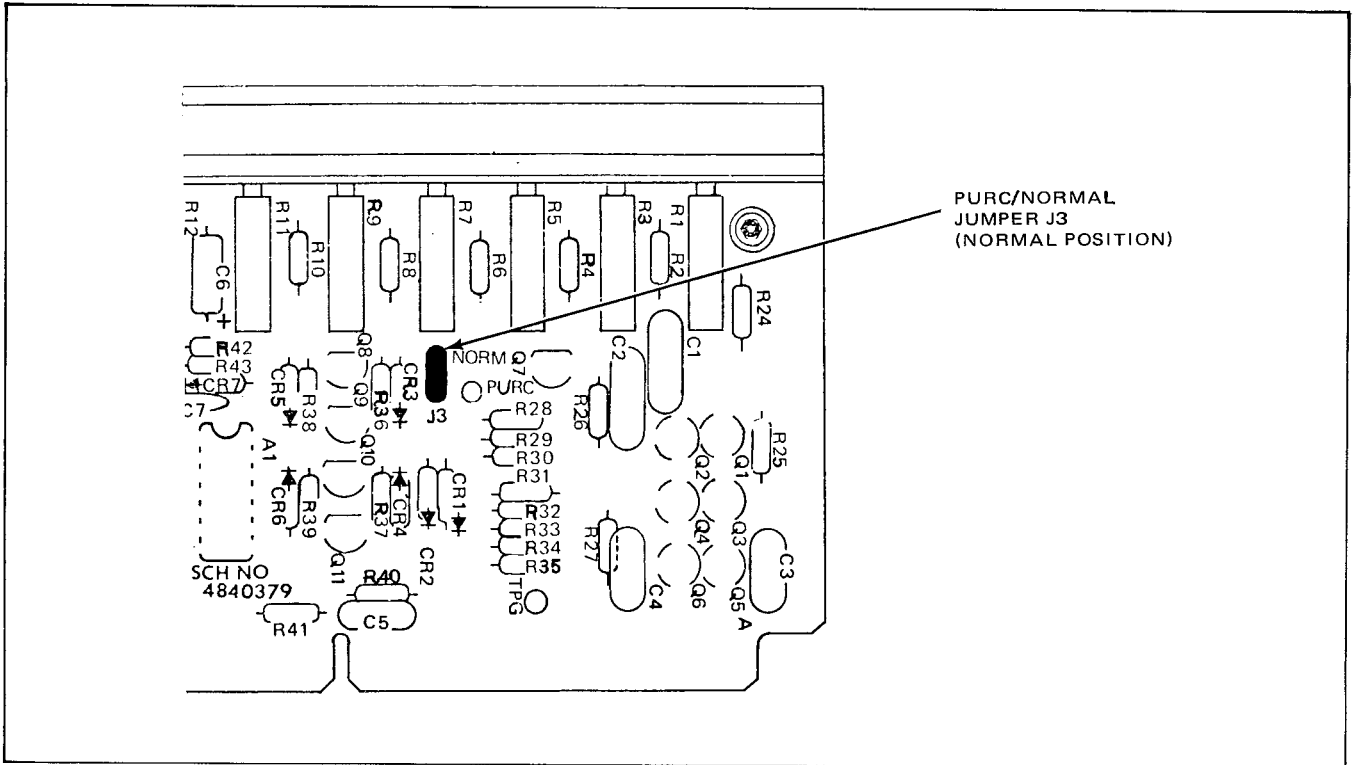

Figure 2-28. PURC Jumper, PADNET PWA

6. Check tape transport operation and control circuitry as follows:
 - a. Press play pushbutton. Transport should operate at speed selected and play indicator should illuminate.
 - b. Press stop pushbutton. Tape should stop and stop indicator should illuminate.
 - c. Press fast forward pushbutton. Transport should enter fast forward mode and fast forward indicator should illuminate.
 - d. Press rewind pushbutton. Transport should enter rewind mode and rewind indicator should illuminate. Press stop pushbutton.
 - e. Simultaneously press play pushbutton and fast forward pushbutton. Transport should enter spool mode in the forward direction. The fast forward indicator should illuminate and the play indicator will illuminate when spool speed is reached.
 - f. Press rewind pushbutton. Transport should enter spool mode in the rewind direction. Rewind indicator should illuminate and play indicator will illuminate when spool speed is reached.
 - g. Press stop pushbutton. Tape should stop and stop indicator should illuminate.
 - h. Turn capstan edit knob by hand in one direction and then the other. Tape should move from reel to reel under reel-servo control.
 - i. Press play pushbutton. Transport should operate at speed selected. Then press EDIT pushbutton. Tape motion should continue in play mode, power is removed from takeup reel, and takeup tension-arm roller engages capstan causing tape to be spilled at takeup side of transport.
 - j. Press stop pushbutton. Tape motion should stop.
 - k. Press play pushbutton. Tape should again be spilled at takeup side of transport.
 - l. Press stop pushbutton. Tape motion should stop.
 - m. Press EDIT pushbutton (after tape has stopped moving). Recorder should enter unthread mode (reel servos disengage) and power should be removed from reel motors.
7. Check signal system control circuitry operation as follows:
 - a. Simultaneously press a channel select pushbutton and the READY pushbutton. The ready indicator (yellow) should illuminate. Repeat this step for all channels as applicable.
 - b. Simultaneously press play and record pushbuttons. The ready indicator should go out, the channel record indicator (red) and the master record indicator (red) should illuminate.
 - c. Press stop pushbutton. The channel record indicator and master record indicator should go out and the ready indicator should illuminate.
 - d. Simultaneously press a channel select pushbutton and the SAFE pushbutton. The safe indicator should illuminate and the ready indicator should go out. Repeat this step for all channels as applicable.
 - e. Simultaneously press play and record pushbuttons. The channel record indicator (red) and the master record indicator should not illuminate.
 - f. Simultaneously press a channel select pushbutton and the SYNC pushbutton. The sync indicator should illuminate. Repeat this step for all channels as applicable.
 - g. Simultaneously press a channel select pushbutton and the REPRO pushbutton.

The repro indicator should illuminate and the SYNC indicator should go out. Repeat this step for all channels as applicable.

- h. Simultaneously press a channel select pushbutton and the INPUT pushbutton. The input indicator should illuminate and the repro indicator should go out. Repeat this step for all channels as applicable.
- i. While holding channel select pushbutton depressed, press READY pushbutton and then press SYNC pushbutton. The ready and sync indicators should illuminate. Simultaneously press play and record pushbuttons. The following action should take place:
 - 1) Transport operates at speed selected.
 - 2) Play and master record indicator illuminates.
 - 3) Channel ready indicator goes out.
 - 4) Channel record indicator illuminates.
 - 5) Sync indicator goes out.
 - 6) Input indicator illuminates.
- j. Press and hold record pushbutton depressed. Momentarily press stop pushbutton. The following action should take place:
 - 1) Transport operates at speed selected.
 - 2) Master record indicator goes out.
 - 3) Channel record indicator goes out.
 - 4) Channel input indicator goes out.
 - 5) Channel ready indicator illuminates.
 - 6) Channel sync indicator illuminates.
- k. Press and hold record and stop pushbuttons depressed. Momentarily press

play pushbutton. Transport should operate at speed selected. Momentarily again press play pushbutton. Channel should enter and stay in record mode (channel record indicator and master record indicator illuminate) as long as play pushbutton is held depressed. Release pushbuttons and then press stop pushbutton. Transport motion should stop.

- l. Repeat steps i, j, and k for all channels as applicable.

2-32. FACTORY SHIPPED OPERATIONAL CONFIGURATION

The basic recorder/reproducer is capable of operating at tape speeds of 3.75, 7.5, 15, and 30 in/s (9.52, 19.05, 38.1, and 76.2 cm/s) in either the NAB or IEC equalization standard. However, the recorder/reproducer is shipped from the factory in the operational configuration given in Table 2-4. Some applications of the recorder/reproducer require a configuration different from those established at the factory. For example, the use of conventional tape requires change of operating level, change of bias, and change of record equalization. To change tape speed or other operational configurations, see Maintenance section of the manual.

2-33. CHECKING OPERATING LEVEL

To check operating level, play back an Ampex standard alignment tape that has the same track format as the recorder/reproducer (full track, 2 track, or 4 track). Proceed as follows:

1. If an input/output assembly is not being used, connect an ac voltmeter to the output of the recorder/reproducer.
2. Reproduce the reference level 500-Hz tone for 3.75 in/s or 700-Hz tone for 7.5, or 30 in/s of an Ampex standard alignment tape (185 nWb/m).
3. If an ac voltmeter is used, the output level should read -11 dBm.

4. If an input/output assembly is being used, set the reproduce MANUAL/PRESET switch to the PRESET position. The input/output assembly level meter should read -6 vu when

meter switch is in the vu position, or meter should read -12 when meter switch is in the peak position. The line output level should be -2 dBm.

Table 2-4. Factory Shipped Operational Configuration

ITEM	SETTING
Operating Speed	7.5 – 15 in/s (19.05 cm/s – 38.1 cm/s)
Equalization Standard	NAB or IEC depending on order specifications
Bias Level Setting	For use with Ampex 456 high-output, low noise tape
Input Impedance	Basic Recorder/Reproducer: 18 kilohms, unbalanced Recorder/Reproducer with Input/Output assembly (accessory): 50 kilohms, balanced
Output Impedance	Basic Recorder/Reproducer: 40 ohms, unbalanced Recorder/Reproducer with Input/Output assembly (accessory)- 30 ohms balanced
Operating Level	370 nWb/m (0 vu on Input/Output level meter) which is 6 dB higher than the 185 nWb/m reference level of Ampex standard tapes. (Note: The basic recorder/reproducer is factory adjusted for -5 dBm input and output line levels. The recorder/reproducer with input/output assembly is factory-adjusted in preset mode switch positions for +4 dBm input and output line levels.)
Power Input	110 - 135 Vac (unless specified otherwise on sales order)