

RECORDER CARE™
BY NORTRONICS®

BROADCAST ■ STUDIO ■ DUPLICATOR

**PROFESSIONAL
TAPE HEAD
REPLACEMENT GUIDE**

INCLUDES SPECIALIZED AUDIO APPLICATIONS

FOURTH EDITION

PRECISE REPLACEMENT HEADS WITH CONSISTENT UNIFORM QUALITY YOU CAN DEPEND UPON!

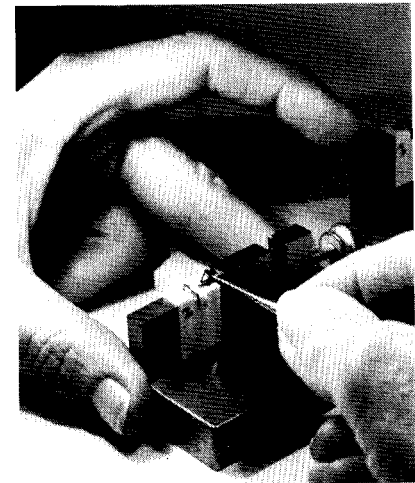
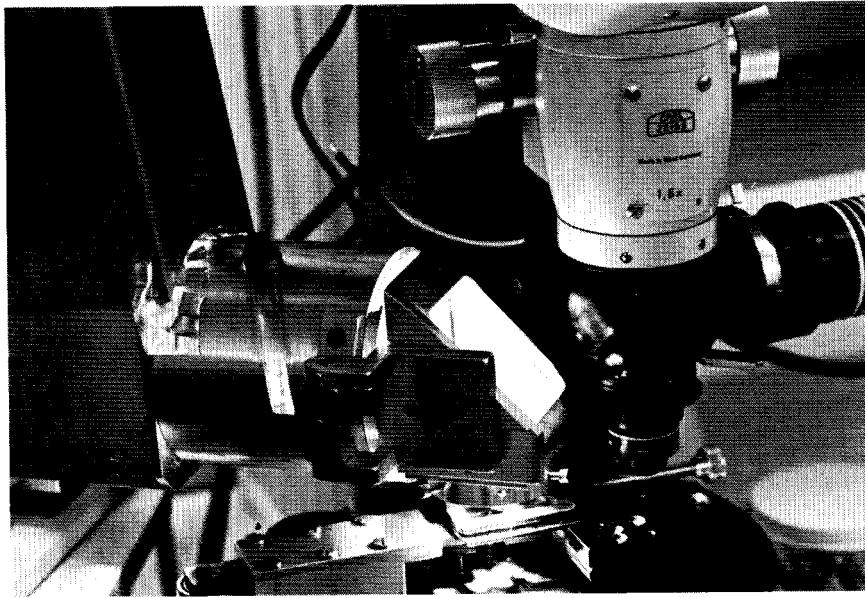

When you use professional recording equipment for demanding professional applications, you just can't afford second best in a replacement head. We know that quality and dependability are the hallmarks of performance in broadcasting, recording studios, tape duplication, and other professional environments where equipment downtime must be minimized and optimum audio quality maximized.

Nortronics' professional replacement heads are available in industry's widest range for virtually all broadcasting, studio, and duplicating equipment. Moreover, each head we manufacture is built with the consistent, uniform quality that ensures that it will be equal to or better than the original head supplied by the equipment manufacturer. As a matter of fact, Nortronics is one of the world's major suppliers of heads to OEM's and chances are good that we built the head you need to replace.

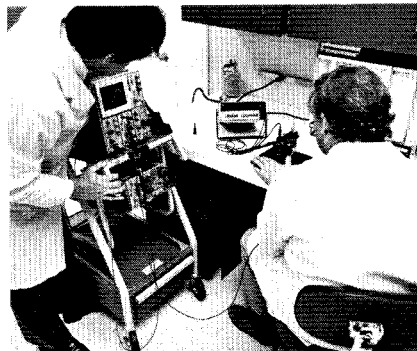

Professional users will also find that Nortronics' replacement heads are readily available from our nationwide distributor network—usually from the distributor's extensive stock—without delays. And, it doesn't end merely with a product. We're pleased to offer technical assistance, application and installation know-how, dependable delivery, and every other support function you should expect from the company that manufactures the finest electrically and mechanically compatible direct replacement heads in the world today!

RECORDER CARE™
A DIVISION OF NORTRONICS®

INDEX

To Find Your Nortronic Replacement Head:

- 1.** If you know **Recorder Model Number** and Head Track Style, refer to Sections A, B, C or D for Head and QK Mounting Hardware, if needed.
- 2.** If you can't find your recorder in these sections, but know the recorder manufacturer's **Head Part No.**, refer to Section E.
- 3.** If you know the Nortronic **OEM Head Number**, refer to Section F to determine the Recorder-Care Number.

Manufacturer's Listed In This Book

Amega (Rangertone)	Lyrec
Ampex	Macarta (see SMC)
Ampro (Instatape)	Magnasync (see Moviola)
ATC (Gates) (Harris)	Magnecord (Telex)
Audi-Cord	MCA
Audiotronics (ATC)	MCI
Automatic Electric	Metrotech (Scully)
(Electronic Secretary)	Micro Magnetics
Beaucart (UMC Electronics)	3M (see Wollensak)
Becht	Moviola (Magnasync)
Broadcast Electronics	Muzak
(see Spotmaster)	Newcomb
Brush (Clevite)	Otari
Cetec	Pentagon
Code-A-Phone (Ford)	Pioneer
Collins	Presto
Concertone (Berlant)	Rapid-Q (Edco) (Garron) (Stacor)
Crown International	Rawdon-Smith (Multitape)
Cuemaster (Consolidated	RCA
Electronics) (Cepak)	Recordex
Dictaphone (see also Metrotech)	Revox
Echoplex (Market) (Gibson-Maestro)	Schafer (Cetec)
Electro Sound	Scully (Scully/Metrotech)
Electronic Secretary	(Dictaphone)
(see Automatic Electric)	L.J. Scully
Fairchild	Showchron (Honeywell)
Fender (Echo-Fonic)	SMC (Macarta) (Sono-Mag)
Ford Industries	Sparta (Cetec)
(see Code-A-Phone)	Spotmaster (Broadcast Electronics)
Gables	Stancil-Hoffman
Garner	Sundstrand (United Control)
Grindley (Tad)	Tad (see Grindley)
Harris (Gates) (ATC)	Tape-Athon
Infonics	Tapecaster
Instatape (see Ampro)	Teac
International Audio (Alpha)	Technics (Panasonic)
International Tapetronics (ITC)	Telex (Magnecord) (Viking)
International Video	Vega
ITC (International Tape)	Viking (Telex)
Lockheed Aircraft Service	Wollensak (3M)

Reel to Reel

PAGES 2-5

Replacement by
Manufacturer &
Model Number

Broadcast Cartridge

PAGES 6-11

Replacement by
Manufacturer &
Model Number

Duplicators Copiers

PAGES 12-13

Replacement by
Manufacturer &
Model Number

Specialized Audio

PAGE 14

Replacement by
Manufacturer &
Model Number

Cross Reference

PAGES 15-20

Manufacturer Head Part
Number to Nortronic Part
Number

Head Specifications & Accessories

PAGES 21-31

Reference Notes and
Abbreviations

PAGE 32

A

B

C

D

E

F

Tape Head Replacements for: Reel-to-Reel

Model No.	Track Style & Ref. Notes	RP or RPE	4th Head or Combo	Record Head & QK	Playback Head & QK	Erase Head & QK
-----------	--------------------------	-----------	-------------------	------------------	--------------------	-----------------

SCULLY/METROTECH (DICTAPHONE) (Continued)						
255-2	2TS 1/4"	P			8202	
255-24	4TS 1/4"	P			8607	
270	FT 1/4" - 16	P			9102+91	
270-1	2TM 1/4" - 16	P			9202+91	
270-2	2TS 1/4" - 16	P			9202+91	
270-24	4TS 1/4" - 16	P			8600+91	
270-44	4TS 1/4" - 39	P			5603+91	
275	FT 1/4" - 16	P			9102+91	
275-1	2TM 1/4" - 16	P			9202+91	
275-2	2TS 1/4" - 16	P			9202+91	
275-24	4TS 1/4" - 16	P			8600+91	
275-44	4TS 1/4" - 39	P			5603+91	
280	FTM 1/4" - 16			9104+91	9102+91	9128+91
280-1	2TM 1/4" - 16			9204+91	9202+91	9223+91
280-2	2TS 1/4" - 16			9204+91	9202+91	9223+91
280-4	4TS 1/4" - 16			8618+91	8600+91	8641+91
280-44	4CH 1/4"			5607+91	5603+91	1402(2)
280B-FT	FTM 1/4"			9104+91	9110+91	9128+91
280B-1	2TM 1/4"			9209+91	9211+91	9223+91
280B-2	2TS 1/4"			9209+91	9211+91	9223+91
280B-24	4TS 1/4"			8618+91	8606+91	8641+91
280B-44	4CH 1/4"			5607+91	5602+91	
282-3	3CH 1/2"			9361	9360	9370
282-4	4CH 1/2"			9461	9460	9470
284-8	8CH 1"			9881	9880	9890
284B-FT	FTM 1/4"			9104+91	9102+91	9128+91
284B-1	2TM 1/4"			9209+91	9211+91	9223+91
284B-2	2TS 1/4"			9209+91	9211+91	9223+91
284B-4	4CH 1/2"			9469	9476	9470
284B-24	2TS 1/4"			8618+91	8606+91	8641+91
284B-44	4CH 1/4"			5607+91	5602+91	
284B-8	8CH 1"			9882	9889	9890
285B-FT	FTM 1/4"			9104+91	9102+91	9128+91
285B-2	2TS 1/4"			9209+91	9211+91	9223+91
285B-24	4TS 1/4"			8618+91	8606+91	8641+91
288-8	8CH 1"			9881	9880	9890
288-12	12CH 1"			9981	9980	9986
288-16	16CH 2"			9992	9990	9996

L. J. SCULLY

LJ-10	2TM	P			9202	
LJ-10	2TS	P			9202	
LJ-10	4TS	P			8600	

STANCIL-HOFFMAN

R70/ARP76	FT			9105	9111	9125
R70/ARP76	2TM			8404	8403	8304
R70/ARP76	2TS			9205	9213	9226
R70/ARP76	4TS			8603	8608	8701
R70/ARP76	4CH			5601	5603	

TAPE-ATHON

Model No.	Track Style & Ref. Notes	RP or RPE	4th Head or Combo	Record Head & QK	Playback Head & QK	Erase Head & QK
CT-1, CT375, 720	2TM			Pair Heads	7405L 7404U	
720, 800	4TM/S				1201+66	
900	FT			9103+66	9119+66	9125+66
900-1	2TM			8401+66	8403+66	9222+66
900-2	2TS			9203+66	9213+66	9222+66
900-4	4TS			8604+66	8608+66	8701+66
900-L2	2T			9203+66	9213+66	9222+66
900-L2-8	8T 2CH			5832+66	5832+66	
900-L4	4T			8604+66	8608+66	8701+66
900-L4-4	4T			8604+66	8608+66	8701+66
900-L4-8	8T 4CH			5832+66	5832+66	
900-L8	8T			5832+66	5832+66	
900-L8-8	8T			5832+66	5832+66	
1000	FT			9103+66	9119+66	9125+66
1400	FT			9103+66	9119+66	9125+66

TEAC

TCA40	4CH			5604+85	5603+85	
TCA41	4CH			5604+85	5603+85	
TCA42	4CH			5604+85	5603+85	
105	FT			9103+85	9119+85	9127+66
105	2TS			9203+85	9213+85	9227+66
105	4TS			8604+85	8608+85	8640+66
110	FT			9103+85	9119+85	9127+66
110	2TS			9203+85	9213+85	9227+66
110	4TS			8604+85	8608+85	8640+66
200	4CH			5604+85	5603+85	

Model No.	Track Style & Ref. Notes	RP or RPE	4th Head or Combo	Record Head & QK	Playback Head & QK	Erase Head & QK
-----------	--------------------------	-----------	-------------------	------------------	--------------------	-----------------

TEAC (Continued)						
310	FT				9103+85	9119+85
310	2TS				9203+85	9213+85
310	4TS				8604+85	8608+85
340	FT				9103+85	9119+85
340	2TS				9203+85	9213+85
340	4TS - 41				8604+85	8608+85
410	4CH				5604+85	5603+85
505	FT				9103+84	9119+84
505	2TS				9203+84	9213+84
505	4TS				8604+84	8608+84
700	FT				9103+85	9119+85
700	2TS				9203+85	9213+85
700	4TS - 41				8604+85	8608+85
1000	FT				9103+85	9119+85
1000	2TS				9203+85	9213+85
1000	4TS - 41				8604+85	8608+85
1200	2TS				8604+85	8608+85
1200	4TS - 41				8604+85	8608+85
1230	4TS				8604+85	8608+85
1250	4TS	RE		6006+85		8607+85
1300	4TS	RE		6006+84		8607+85
1340	4CH				5604+85	5603+85
1400	4TS				8604+85	8608+85
1500	2TS				9203+85	9207+85
1500	4TS - 41				8604+85	8607+85
1600	2TS				9203+85	9207+85
1600	4TS - 41				8604	8607+85
2010	4TS - 41	RP		8607+85		8640+66
2020	4TS - 41	RP		8607+85		8640+66
2040	4TS - 41	RP		8607+85		8640+66
2050	4TS - 41	RP		8607+85		8640+66
2070	4TS - 41	RP		8607+85		8640+66
2080	4TS - 41	RP		8607+85		8640+66
2100	2TS				9203+85	9213+85
2100	4TS - 41				8604+85	8608+85
2300	2TS				9203+85	9213+85
2300	4TS - 41				8604+85	8608+85
2340	4CH				5604+85	5603+85
2500	4TS	RE		6006+85		8607+85
2520	4TS	RE		6006+85		8607+85
3300	2TS				9203+85	9213+85
3300	4TS				8604+85	8608+85
3340	4CH				5604+85	5603+85
4010	FT				9103+85	9119+85
4010	2TS				9203+85	9213+85
4010	4TS - 24				8604+85	8608+85
4010SRA	4CH				5604+85	5603+85
4020	4TS - 41	RP		8607+85		8640+66
4070	4TS	RE		6006+85		8607+85
4300	4TS - 41				8604+85	8608+85
5000	4TS - 41				8604+85	8608+85
5010	4TS - 41				8604+85	8608+85
5300	4TS - 41				8604+85	8608+85
5500	4TS - 41				8604+85	8608+85
6000	FT				9103+85	9119+85
6000	2TS				9203+85	9213+85
6000	4TS - 41				8604+85	8608+85
6010	4TS - 24, 41				8604+85	8608+85
6100	2TS			8608 (P)	9203+85	9213+85
6300	2TS			8608 (P)	9203+85	9213+85
7010	2TS				9203+85	9213+85
7010	4TS				8604+85	8608+85
7040	4CH				5604+85	5603+85
7300	2TS				9203+85	9213+85

TECHNICS (PANASONIC)

RS-1500-US	S2T		4TS P	8608+102	9203+102	9213+102	9227+102
RS-1506-US	4TS		2TS P	9213+102	8604+102	8608+102	

TELEX (VIKING) (Also see MAGNECOD)

Studio 96	FT - 25				9105	9111	4400L
Studio 96	2TM - 25				3205	3201	3600L
Studio 96	2TS - 25				2005	9213	2200L
Studio 96	4TS - 25				1205	8608	1400L
Studio 96	FT - 26				9105	9111	4401L
Studio 96	2TM - 26				3203	3201	3601L
Studio 96	2TS - 26				9205	9213	2201L
Studio 96	4TS - 26				1203	8608	1401L
230	FT				9105	9111	4401L
230	2TM				3203	3201	3601L
230	2TS				2003	2001	2201L
230	4TS				1203	1201	1401L

VEGA

800	2TS		4TS	8609+76	9204+76	9209+76	9227+76
-----	-----	--	-----	---------	---------	---------	---------

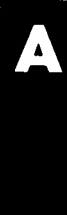

Nortronics Tape Head Replacements and Conversion Guide for: Broadcast Cartridge Recorders

SECTION **B**

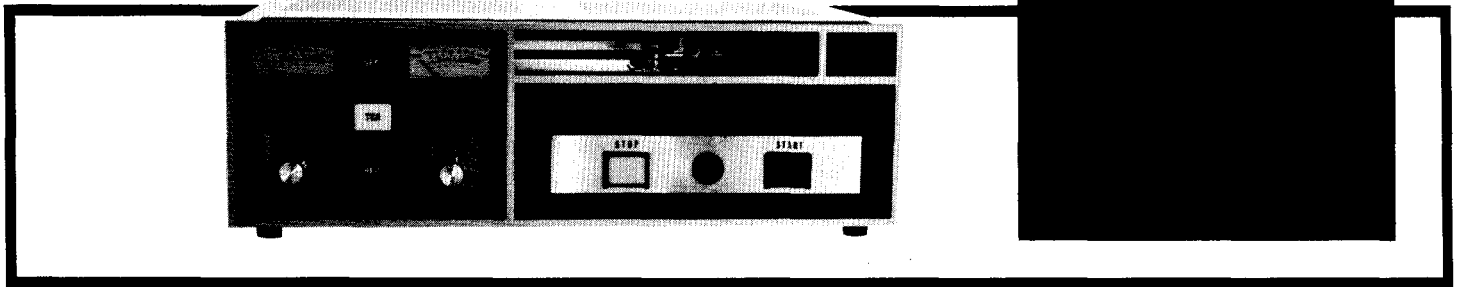

INTRODUCTION

Nortronics heads are standard as original equipment on most broadcast cartridge machines, and the tables in Section B should permit the selection of the correct replacement head for over 90% of the transports in existence. If the machine has a Nortronics head it can be identified by the OEM part number stamped on it, such as "P-B2H7K" or its equivalent RCD number "2001". Cross-reference between OEM and RCD numbers is given with Head Specs in Section F.

REPLACEMENT LISTING

1. The first column of the following machine/head listings gives the recorder model number and indicates if it is a Mono (2-channel heads) or a Stereo (3-channel) machine. Delay machines are always mono, but may use either single-channel or two-channel heads.
2. The second column gives the machine manufacturer's head part number, which probably will not be stamped on the head, but which will most likely appear in the parts list in the machine maintenance manual.
3. The third column gives *head function*. Each machine usually has two heads; one to *record program and cue*, and the other head to *play program and cue*. Mono recorders use the top channel for program and the lower channel for cue, utilizing two-channel heads. Early mono machines incorporated single channel heads, one to *record and play program*, and the other to *record and play cue*; no monitoring during recording was possible as in current "NAB Standard" machines. (See "NAB CONVERSION" below for possible modification to two-channel heads.)

Stereo machines use three-channel heads, with the program on the top two channels and cue on the lower. Play-only machines have only one active head, playback, and often place a dummy head in the record position to support the tape for better guidance.

Delay cartridge recorders generate the typical seven second time delay needed for live telephone talk shows. They use a special combination erase-record head next to the capstan, plus a normal play head located in the left position. The tape sequence is play, erase, record, delay, and again play. Early delay-only machines used single-channel heads, while the more recent machines have two channel heads so they can also be used for conventional playback and record.

4. The fourth column ("Mount Type") shows the mounting style of the original heads. The first cartridge machines used exclusively rear-mount heads with the 1/4-28 threaded mounting stud. Recent models use mostly no-mount heads which are easier to install and more convenient to adjust. Be sure to verify the head mounting style on your machine as it may have been converted to no-mount heads with the aid of a Nortronics QK-114 cartridge-mount kit.
5. The fifth column ("Orig. Head") indicates the Nortronics RCD head number to replace the original equipment heads. In some cases a two-channel head is specified as a replacement instead of the original single-channel head furnished on early recorders; if so, use only one channel of the head. Note that the part number for a rear-mount head is derived by adding 50 to the equivalent no-mount head, i.e. 2001 becomes the 2051 rear-mount head.
6. The sixth column ("Duracore") indicates the equivalent long-wear Duracore head, when available, and is usually the regular head number with the letter D added. Some machines are supplied with Duracore heads as original equipment.
7. The seventh column ("No-Mount Conversion") shows the heads and Quik-Kit to convert from rear-mount heads to no-mount, when practical and feasible. On certain Harris and RCA machines, as indicated in the application notes, conversion is not recommended.

NAB CONVERSION

The very early cartridge machines equipped with single-channel heads can sometimes be converted to "NAB monitor" by replacing the single-channel heads with two-channel types. However, this requires modification of the electronics to separate the record and playback functions, and can be a fairly difficult task. Write to NORTRONICS RCD giving make and model of recorder and we will try to give assistance when possible.

CAUTION

Care should be taken to avoid striking the face of the tape heads with any hard object and this does include the cartridge itself, which can dent the head face if inserted at an angle. Use of a hold-down spring and side-guide rail is highly recommended.

Penetration of the head into the cartridge should be set at 9/32-in. Excessive penetration will cause faster head wear and possible tape skewing.

QUIK-KITS

QK-114 installs two no-mount B-size heads on a cartridge transport. It includes micrometer adjustments for head position, a cartridge hold-down spring, and side-guide rail to control cartridge insertion.

QK-110 installs two no-mount B-size heads, with provision for third head. Third bracket not included—order QK-112 if needed. Includes phono jacks and head plugs, plus cartridge side-guide rail and hold-down spring.

QK-112 is the single B-size head bracket and mounting screws to fit either QK-100 or QK-114.

**QK-114 Type
2-Head Nest**

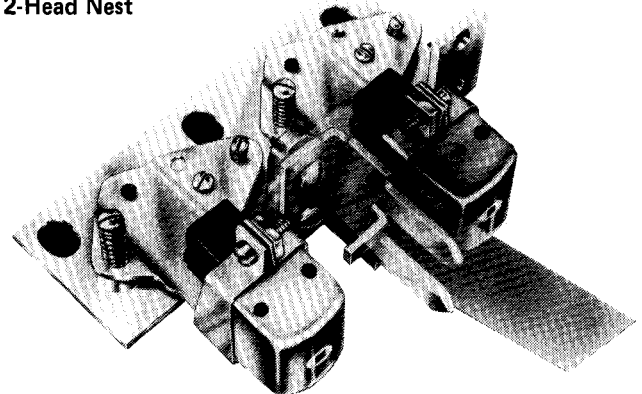

**QK-110 Type
3-Head Nest**

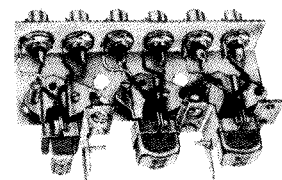

Tape Head Replacements for: Broadcast Cartridge Recorders

RECORDER MANUFACTURER AND MODEL	ORIGINAL HEADS			NORTRONICS REPLACEMENT			SPECIAL NOTES
	Mfgr. Head No.	Head Function	Mount Type	Original Head	Dura-core	No-Mount Conversion	

AMPRO (INSTATAPE)

CT-2500, 3500, 4500 5500 Series Mono	9086-1 9103-1	Record Program & Cue Play Program & Cue	No Mount	2010 2001	2010D 2001D		Play-only machines have no record head. Use 7605 for dummy record head.
CT-2500, 3500, 4500, 5500 Series Stereo	9085-1 9102-1	Record Program & Cue Play Program & Cue	No Mount	5710 5701	— 5701D		

ATC (GATES) (Also see HARRIS)

Criterion CP11, CP12, CP13 Mono	20-1014 20-1011	Record Program & Cue Play Program & Cue	Rear Mount	2053 2057	2053D 2057D	*	Play-only machines have no record head. Use 7605 for dummy record head. *Conversion to No-Mount heads not recommended.
Criterion CP11, CP12, CP13 Stereo	20-1016 20-1015	Record Program & Cue Play Program & Cue	Rear Mount	5753 5757	5753D —	*	
P150, P190, PB150, PB190, PC150, PC190 Mono	20-1001 20-1001	Record/Play Program Record/Play Cue	Rear Mount	2051 2050		2001 } 2000 } 114	

AUDI-CORD

100, 101 Mono		Dummy Head* Play	No Mount	7605 2001	7605D 2001D		*Play-only machines substitute dummy head for record head.
105, 106 Stereo		Dummy Head* Play	No Mount	7605 5701	7605D 5701D		
110, 111 Mono		Record Play	No Mount	2003 2001	2003D 2001D		
115, 116 Stereo		Record Play	No Mount	5703 5701	5703D 5701D		
120, 121 Mono		Record Play	No Mount	2003 2001	2003D 2001D		
125, 126 Stereo		Record Play	No Mount	5703 5701	5703D 5701D		
130, 132, 134, 136 Network Delay		Play	No Mount	2000			
131, 133, 135, 137 Delay	P-A2H44R	Erase/Record Play	No Mount	6101 2001	2001D		
140, 141 Mono		Play	No Mount	2001	2001D		
145, 146 Stereo		Play	No Mount	5701	5701D		
127 4-Chan.		Record Play	No Mount	5601 5603			

BEAUCART (UMC ELECTRONICS)

11-X1X-XXX Mono	BH-1001 BH-3001	Dummy Head* Play	No Mount	7605 2001	7605D 2001D		*Play-only machines substitute dummy head for record head.
11-X2X-XXX Stereo	BH-1001 BH-5001	Dummy Head* Play	No Mount	7605 5701	7605D 5701D		
12-X1X-XXX Mono	BH-2001 BH-3001	Record Play	No Mount	2003 2001	2003D 2001D		
12-X2X-XXX Stereo	BH-4001 BH-5001	Record Play	No Mount	5703 5701	5703D 5701D		
13-X1X-XXX Mono	BH-1001 BH-3001	Dummy Head* Play	No Mount	7605 2001	7605D 2001D		
13-X2X-XXX Stereo	BH-1001 BH-5001	Dummy Head* Play	No Mount	7605 5701	7605D 5701D		
14-X1X-XXX Mono	BH-2001 BH-3001	Record Play	No Mount	2003 2001	2003D 2001D		
14-X2X-XXX Stereo	BH-4001 BH-5001	Record Play	No Mount	5703 5701	5703D 5701D		
21-X1X-XXX Mono	BH-1001 BH-3001	Dummy Head* Play	No Mount	7605 2001	7605D 2001D		

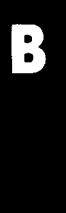

Tape Head Replacements for: Broadcast Cartridge Recorders

RECORDER MANUFACTURER AND MODEL	ORIGINAL HEADS			NORTRONICS REPLACEMENT			SPECIAL NOTES
	Mfgr. Head No.	Head Function	Mount Type	Original Head	Dura-core	No-Mount Conversion	

BEAUCART (UMC ELECTRONICS) Continued

21-X2X-XXX	Stereo	BH-1001 BH-5001	Dummy Head* Play	No Mount	7605 5701	7605D 5701D		*Play-only machines substitute dummy head for record head.
22-X1X-XXX	Mono	BH-2001 BH-3001	Record Play	No Mount	2003 2001	2003D 2001D		
22-X1X-011	Mono Delay	BH-2001 P-A2H44R BH-3001	Record Erase/Record Play	No Mount	2003 6101 2001	2003D 6101 2001D		
22-X1X-021	Mono Delay	BH-2001 B1EF4J BH-3001	Record Erase Play	No Mount	2003 8104 2001	2003D 2001D		
22-X2X-XXX	Stereo	BH-4001 BH-5001	Record Play	No Mount	5703 5701	5703D 5701D		
22-X5X-XXX	Stereo	BH-4005 BH-5001	Record Play	No Mount	— 5701	5701D		
41-X1X-XXX	Mono	BH-3001	Play	No Mount	2001	2001D		
42-X1X-XXX	Mono	BH-2001 BH-3001	Record Play	No Mount	2003 2001	2003D 2001D		

COLLINS

P150, P190, PB150, PB190	Mono	235-0012 235-0012	Record/Play Program Record/Play Cue	Rear Mount	2051 2050		2001 } 2000 } 114	Requires circuit modification. See Nortronics Form 7213
642A-1, 642A-2	Mono	235-0012 235-0012	Record/Play Program Record/Play Cue	Rear Mount	2051 2050		2001 } 2000 } 114	Play-only machines have no record head. For dummy head use #7605.
642E-1	Mono	020-8000-040 020-8000-030	Record Program & Cue Play Program & Cue	No Mount	2003 2007	2003D 2007D		
642E-2	Stereo	020-8000-010 020-8000-020	Record Program & Cue Play Program & Cue	No Mount	5703 5707	5703D		

CUEMASTER (CEI)

CT85, 751, 753, 754, 756, 757, 903, 906, Cuerac	Mono		Erase/Rec. Prog. & Cue Play Program & Cue	Rear Mount	6151 2050			Play-only machines have no record head. For dummy head use #7605.
983, 986, Cuerac	Stereo		Record Program & Cue Play Program & Cue	Rear Mount	5753 5751	5753D 5751D		

HARRIS (GATES) (ATC)

M5944	Mono	730-0329 730-0330	R/P — Program R/P — Cue	Rear Mount	2051 2050	— —	2001 } 2000 } 114	NOTES: 1. Play units take play head only. 2. Additional head numbers in Section E. 3. Use #7605 for dummy record head. 4. Conversion to No-Mount heads not recommended.
M6211, M6213	Mono	730-0343 730-0423	Record-Program & Cue Play-Program & Cue ¹	Rear Mount	2052 2052 ¹	2052D 2052D ¹	2002D } 2002D } 114	
M6212, M6214	Stereo	730-0726 730-0727	Record-Program & Cue Play-Program & Cue ¹	Rear Mount	5753 5751 ¹	5753D 5751D ¹	5703 } 5701 } 114	
Criterion I, II, III Compact	Mono	730-1429 730-1376	Record-Program & Cue Play-Program & Cue ¹	No Mount	2003 2007 ¹	2003D 2007D ¹		
Criterion I, II, III Compact	Stereo	730-0730 730-1371	Record-Program & Cue Play-Program & Cue ¹	No Mount	5703 5707 ¹	5703D 5701D ¹		
Criterion 80	Mono	730-1155 730-1153	Record-Program & Cue Play-Program & Cue ¹	Rear Mount	2053 2057 ¹	2053D 2051D ¹	Note 4.	
Criterion 80	Stereo	730-1157 730-1156	Record-Program & Cue Play-Program & Cue ¹	Rear Mount	5753 5757 ¹	5753D 5751D ¹	Note 4.	
Criterion 90	Mono	730-1429 730-1376	Record-Program & Cue Play-Program & Cue ¹	No Mount	2003 2007 ¹	2003D 2001D ¹		
Criterion 90	Stereo	730-0730 730-1371	Record-Program & Cue Play-Program & Cue ¹	No Mount	5703 5707 ¹	5703D 5701D ¹		
KSP-10	Delay	730-1439 730-1376	Combo Erase/Record Play	No Mount	6103 2007			

Tape Head Replacements for: Broadcast Cartridge Recorders

RECORDER MANUFACTURER AND MODEL	ORIGINAL HEADS			NORTRONICS REPLACEMENT			SPECIAL NOTES
	Mfgr. Head No.	Head Function	Mount Type	Original Head	Dura- core	No-Mount Conversion	

INTERNATIONAL TAPETRONICS (ITC)

Encore Series	Mono	504-0006 504-0001 504-0003	Playback Dummy Head* Record	No Mount	2001 7605 2003	2001D 7605D 2003D		*Play-only machines substitute dummy head for record head. **Original heads are Duracore.
PD-II Series	Mono	504-0020 504-0021	Playback Record	No Mount	2001 2003	2001D 2003D		
RP Series SP Series WP Series	Mono	504-0002 504-0001 504-0003	Playback Dummy Head* Record	No Mount	--** -- --	2001D 7605D 2003D		
RP Series SP Series WP Series	Stereo	504-0004 504-0001 504-0005	Playback Dummy Head* Record	No Mount	--** -- --	5701D 7605D 5703D		
RPD Series	Delay	504-0011 504-0002	Combo Erase/Record Playback	No Mount	6101 --	-- 2001D		
3D Series	Mono	504-0002 504-0001 504-0003	Playback Dummy Head* Record	No Mount	--** -- --	2001D 7605D 2003D		
3D Series	Stereo	504-0004 504-0001 504-0005	Playback Dummy Head* Record	No Mount	--** -- --	5701D 7605D 5703D		

MACARTA (See SMC)

RAPID-Q (EDCO) (GARRON) (STACOR)

RQ Series	Mono		Record Playback ¹	No Mount	2003 2002	2003D 2002D		1. Play-only machines have no record head. For dummy head use #7605.
RQ Series	Stereo		Record Playback ¹	No Mount	5703 5702	5703D		

RCA

RT-7A ²	Mono	223320 223320	Record/Play Program ⁴ Record/Play Cue	Rear Mount	2051 2051		2001 } 1142 2001 }	1. Program head is next to the capstan. 2. NAB monitor conversion of RT-7 series to two-channel heads is described in Nortronics Form #7407. Order a copy from RCD Div. of Nortronics. Different heads are specified from those on this sheet. 3. Quik-Kit conversion to No-Mount heads is not recommended. 4. Play-only machines have no record head. Use #7605 for dummy head, (No-Mount) or 7655 (Rear Mount). 5. "A" Series takes different record head from older "non-A" machines.
RT-7B, RT-7C, RT-7D ²	Mono	226517 223320	Record/Play Program ⁴ Record/Play Cue	Rear Mount	2052 2051		2002 } 1142 2001 }	
RT-8, RT-17, RT-27, RT-37	Mono	231290 231290	Record Program & Cue ⁴ Play Program & Cue	Rear Mount	2052 2052	2052D 2052D	Note 3.	
RT-8, RT-17, RT-27, RT-37	Stereo	231289 231289	Record Program & Cue ⁴ Play Program & Cue	Rear Mount	5752 5752		Note 3.	
RT-125, RT-126, RT-127	Mono	Note 5.	Record Program & Cue ⁴ Play Program & Cue	No Mount	2010 2001	2010D 2001D		
RT-125, RT-126, RT-127	Stereo	Note 5.	Record Program & Cue ⁴ Play Program & Cue	No Mount	5710 5701	5701D		
RT-125A, RT-126A, RT-127A	Mono	Note 5.	Record Program & Cue ⁴ Play Program & Cue	No Mount	2003 2001	2003D 2001D		
RT-125A, RT-126A, RT-127A	Stereo	Note 5.	Record Program & Cue ⁴ Play Program & Cue	No Mount	5703 5701	5703D 5701D		

SCHAFFER (CETEC)

Audiofile	Mono	P-B2H4R P-B2H7K	Record-Program & Cue Play-Program & Cue	No Mount	2003 2001	2003D 2001D		Play-only machines have no record head. For dummy head use #7605.
Audiofile	Stereo	P-B3Q4R P-B3Q7K	Record-Program & Cue Play-Program & Cue	No Mount	5703 5701	5703D 5701D		

Tape Head Replacements for: Broadcast Cartridge Recorders

RECORDER MANUFACTURER AND MODEL	ORIGINAL HEADS			NORTRONICS REPLACEMENT			SPECIAL NOTES
	Mfrg. Head No.	Head Function	Mount Type	Original Head	Dura- core	No-Mount Conversion	

SMC (MACARTA) (SONO-MAG)

105/108	Mono	P-G1H7K-N P-G1H7K-N	Record/Play Program Record/Play Cue	No Mount	2001 2001	2001D 2001D	Notes 1, 2	NOTES: 1. QK-114 needed if machine has rear-mount heads. 2. Play-only machines have no record head. Use #7605 for dummy head.
208	4T Stereo	P-B2Q7K	Play Program	No Mount	8608		Notes 1, 2	
245 & 248 & 250 Carousel, 500, 510, 710, 721, 790 Caro-Stat, Mark II	Mono	P-B2H2K	Play, Program & Cue	No Mount	2000		Notes 1, 2	
245-2 & 248-2 & 252 Carousel, 502, 512, 572, 712, 722, 792, Mark II	Stereo	P-B3Q7K	Play, Program & Cue	No Mount	5701	5701D	Notes 1, 2	
560, 570, 590, 770, 790	Mono	P-B2H4R P-B2H7K	Record, Program & Cue Play, Program & Cue	No Mount	2003 2001	2003D 2001D	Note 1	
572, 592, 772, 792	Stereo	P-B3Q4R P-B3Q7K	Record, Program & Cue Play, Program & Cue	No Mount	5703 5701	5703D 5701D	Note 1	
593, 793	Delay Mono	P-A1HC44R P-B1HY2K	Erase/Record Program Play Program	No Mount	6126 2600			
2405/2408 Carousel	Mono	P-G1H7K-N P-G1H7K-N	Play Program Play Cue	No Mount	2001		Notes 1, 2	

SPARTA (CETEC)

CD 15-2	Delay	895-0030 895-0020	R/P/E (Combo Head) Play	No Mount	6127 2601		QK-114 ²	NOTES: 1. Playback units take play head only. 2. Early units with rear mount heads need QK. 3. For dummy head use #7605.
BP11, BP22, BP22B, BP22C, CP-5, Play, Port.	Mono	895-0024	Play-Program & Cue	Side Mount	2001+38			
200P, 200RP, 300P, 300RP	Mono	895-0022 895-0022	Record/Play-Program Record/Play-Cue	Rear Mount	2051 2051		2001 } 114 2001 }	
MC104, 300B, 300C, 400P, 400RP, 800P, 800RP, 4510, 4515, 4610, 4615, Century	Mono	895-0010 895-0020	Record-Program & Cue Play-Program & Cue	No Mount	2003 2001 ¹	2003D 2001D		
MC204, 200P, 200RP 600P, 600RP, 4520, 4620, 4625, Century	Stereo	895-0040 895-0042	Record-Program & Cue Play-Program & Cue	No Mount	5703 5701 ¹	5703D 5701D	QK-114 ²	

SPOTMASTER (BROADCAST ELECTRONICS)

303, 305, 400 405, 500, 505 605, 610, 1070, three/70, 2000	Mono	DM2RB DM1B ¹ DM2RC ² DM1C ²	Record-Program & Cue Play-Program & Cue Record-Program & Cue Play-Program & Cue	Rear Mount Rear Mount	2053 2051 ¹ 7252 ² 7251 ²	2053D 2051D ¹ — —	2003 } 114 2001 }	NOTES: 1. Play units take play heads only. 2. Special narrow "C" size (3/8" wide) heads used on some models. Use only where needed. 3. Early units. 4. Later units furnished with Dura-core heads. 5. Additional head part numbers in Section E.
303, 305, 500, 605, 610, 1070RPS, 2000	Stereo	DM3RB D1SA ¹ DM3RC ²	Record-Program & Cue Play-Program & Cue Record-Program & Cue	Rear Mount Rear Mount	5753 5751 ¹ 7253 ²	5753D 5751D —		
3000, 4000, 5000, 5300, 5500	Mono	M1R ³ M1P ^{1,3} LMR ⁴ LMP ^{1,4}	Record-Program & Cue Play-Program & Cue Record-Program & Cue Play-Program & Cue	No Mount No Mount	2003 ³ 2001 ^{1,3} — —	2003D 2001D 2003D ⁴ 2001D ^{1,4}		
3000, 4000, 5000, 5300, 5500	Stereo	S1R ³ S1P ^{1,3} LSR ⁴ LSP ^{1,4}	Record-Program & Cue Play-Program & Cue Record-Program & Cue Play-Program & Cue	No Mount No Mount	5703 ³ 5701 ^{1,3} — —	5703D 5701D 5703D ⁴ 5701D ^{1,4}		
500, 1070	Delay	DL2C DM1B	Combo Erase-Record Play-Program & Cue	Rear Mount	6151 2051	— 2051D	6101 } 114 2001 }	
3000	Delay	DL2D LMP	Combo Erase-Record Play-Program & Cue	No Mount	6101 —	— 2001D		

Tape Head Replacements for: Broadcast Cartridge Recorders

RECORDER MANUFACTURER AND MODEL	ORIGINAL HEADS			NORTRONICS REPLACEMENT			SPECIAL NOTES
	Mfgr. Head No.	Head Function	Mount Type	Original Head	Dura- core	No-Mount Conversion	

TAPECASTER

600P, 600RP	Mono	P-G1H7K-R G1H2K-R	Record/Play-Program Record/Play-Cue	Rear Mount	2051 2050		2001 } 2000 } 114	<p>Older vacuum tube models will take the same heads listed.</p> <p>NOTES:</p> <p>1. Mono record and play heads are same type.</p> <p>2. Play-only and stereo machines have dummy head in left position.</p> <p>3. Either "R" (short stud) or "R6" (long stud) rear mount heads will fit 700 series.</p> <p>4. Only "R6" (long stud) heads will fit X700 series and precision head bracket.</p>
700P, 700RP	Mono	P-B2H7K-R ³ P-B2H7K-R6	Record & Play ^{1,2} (2 heads, same)	Rear Mount	2051 ¹ 2056	or	2001 ¹ } 2001 } 114	
700PS, 700RPS	Stereo	P-B3Q7K-R ³ P-B3Q7K-R6	R/P-Program & Cue ² (1 head only) ²	Rear Mount	5751 5754	or	5701+114	
X700P, X700RP	Mono	P-B2H7K-R6 ⁴ P-B2H7K-R6	Record-Program & Cue Play-Program & Cue ²	Rear Mount	2056 ⁴ 2056			
X700PS, X700RPS	Stereo	P-B3Q7K-R6 ⁴	R/P-Program & Cue ² (1 head only)	Rear Mount	5754 ⁴			
700RPD, X700RPD	Delay	P-A2H47K-R6 ⁴ P-B2H7K-R6	Rec/Erase-Prog. & Cue Play-Program & Cue	Rear Mount	6152 2056			
Dummy Head ² (used on Mono-play and on Stereo units)				Rear Mount	7655			
				No Mount	7605			

TELEX/MAGNECORDER

MC-P3	Mono	55748 55742	Play-Program & Cue Dummy Head	No Mount	2001D 7605D	2001D 7605D	
MC-PR3	Mono	55747 55748	Record-Program & Cue Play-Program & Cue	No Mount	2003D 2001D	2003D 2001D	
MC-PS3	Stereo	55746 55742	Play-Program & Cue Dummy Head	No Mount	5701D 7605D	5701D 7605D	
MC-PRS3	Stereo	55745 55746	Record-Program & Cue Play-Program & Cue	No Mount	5703D 5701D	5703D 5701D	

B

Nortronics Tape Head Replacements for: Duplicators/Copiers

SECTION C

This section lists Nortronics replacement heads by manufacturer's model number of machine. Particular attention should be noted to confirm track style and application. See also Section E.

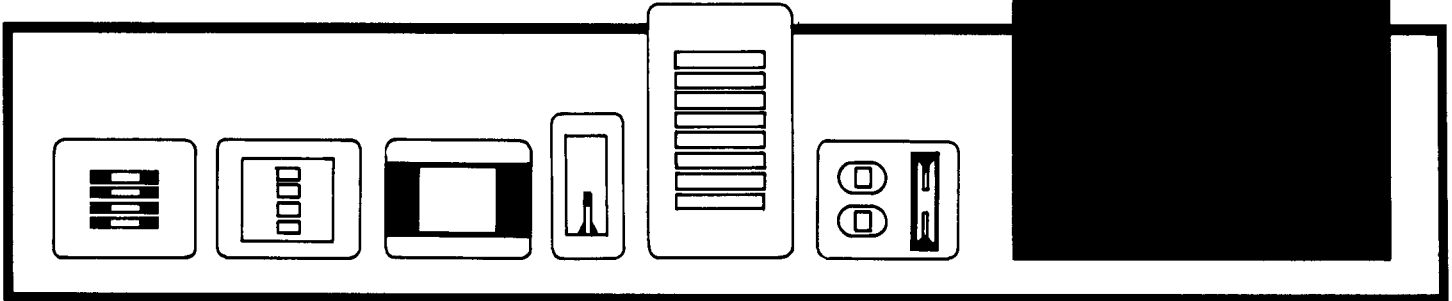

NOTE: "D" indicates long life Duracore Heads.

Model No.	Track Style & Ref. Notes	Master Play Head & QK	Slave Record Head & QK	Erase Head
AMPEX				
PD-10	2TS R-R	9211/9211D+87	9214/9214D+87	
PD-10	4TS R-R	8606+87	8614+87	
PD-10	FTM R-R	9110+87	9113+87	
3200	2TM R-R	8409+76	8414+76	
3200	2TS/M R-R	9206/9206D+76	9214/9214D+76	
3200	FTM R-R	9109/9209D+76	9113/9113D+76	
3200	4TS R-R	8610+76	8614+76	
3200	4CH 8T	5840+76	5843+76	
3200	2T CASS - 31	9206/9206D+76	5220D+76	
3200	4T CASS - 31	5606+76	5417D+76	
3300	- 46			
3400	- 46			

AUDIOTRONICS (ATC)

AV-132	2TM R-R	8402+38	8401+38	
AV-132	FTM R-R	8402+38	9204+38	
AV-132B	2TM R-R	8402+38	8401+38	
AV-132C	4TS R-R	8610+38	8604+38	

BECHT

BE900	8T R-R SL		5810 (4)	
BE910	8T R-R SL		5810 (4)	
BE1000	8T R-R MAS	5800 (4)		
BE1010	8T R-R MAS	5800 (4)		
BE1910	8T CART SL		5841 (2)	
BE2010	8T CART MAS	5842 (2)		
BE2900	4CH CASS SL		5411/5411D	
BE3000	4CH CASS MAS	5410/5410D		

CETEC

Copy-Cass II	2/4T C-C	5413D	5412/5412D	
--------------	----------	-------	------------	--

GARNER

1056	FTM R-R	9106/9109D	9104/9104D	
1056	2T 1/4" R-R	9206/9206D	9204/9204D	

GRINDLEY (TAD)

R-1017	2T 1/4" R-M-C	9206/9206D	5201/5201D	
R-1017	4T 1/4" R-M-C	5606	5411/5411D	
R-1017	FTM 1/4" R-R	9206/9206D	9103/9103D	
R-1017	2T 1/4" R-R	9206/9206D	9203/9203D	

INFONICS

CC-2	2T C-C	5205/5205D	5201/5201D	
CC-4	4T C-C	5413/5413D	5411/5411D	
CS-2	2T CAS SL		5201/5201D	
CS-4	4T CAS SL		5411/5411D	
D-8	8T 1/4" R-R	5890	5891	
RC-2	2T 1/4" R-C	8210/9206D	5201/5201D	
RC-4	4T 1/4" R-C	5606	5411/5411D	
RCC-2	2T 1/4" R/C-C	8210/9206D 5205/5205D	5201/5201D	
RCC-4	4T 1/4" R/C-C	5606 5413/5413D	5411/5411D	
RR-1	FT 1/4" R-R	9156	9164	
RR-2	2T 1/4" R-R	8260	8251	
RR-4	4T 1/4" R-R	5656	5654	
RS-2	2T 1/4" R SL		8251	
RS-4	4T 1/4" R SL		5654	
74M	FT 1/4" R-R	9156	9153	

Model No.	Track Style & Ref. Notes	Master Play Head & QK	Slave Record Head & QK	Erase Head
INFONICS (Continued)				
74S	2T 1/4" R-R	8260	8251	
102	2T C-C	5205/5205D	5201/5201D	
202	2T 1/4" R/C-C	8210/9206D 5205/5205D	5201/5201D	
204	4T 1/2" R/C-C	5606 5413/5413D	5411/5411D	
212	2T 1/4" R MAS	8210/9206D		
214	4T 1/4" R MAS	5606		
252	2T C SL		5220D	
254	4T C SL		5417D	
272	2T R SL		9214D	
274	4T R SL		5607	
292	2T 1/4" R MAS	8210/9206D		
294	4T 1/4" R MAS	5606		
352	2T CAS SL		5220D	
354	4T C SL		5417D	

INTERNATIONAL AUDIO (ALPHA)

ALPHA 21	2T C-C	5205/5205D	5220/5220D	
ALPHA 22	2T C SL		5220/5220D	
ALPHA 41	4T C-C	5413D	5417D	
ALPHA 44	4T C SL		5417D	

LYREC

P-2000	2T 1/4" BM-CT	8609	5225	9118 (Mon.)
P-2000	4T 1/2" BM-CT	9477	5415D	9118 (Mon.)
P-2000	4T 1/4" BM-CT	8609 (2)	5415D	9118 (Mon.)

MAGNECORD (TELEX)

1000D-DMT	2T R-R	9211/9211D	2004	
1000D-DST	4TS R-R	8610	8614	

MAGNEFAX

Tube Types	FT R-R	2608/2608D	9103/9103D	
Tubes	2T 1/4" R-R	9206/9206D	9203/9203D	
Tubes	4T 1/4" R-R	5606	5607	
Solid State	FT R-R	2608/2608D	9104/9104D	
Solid State	2T 1/4" R-R	9206/9206D	9204/9204D	
Solid State	4T 1/4" R-R	5606	5607	
Solid State	2T CAS R-R	8610	5220D	
Solid State	4T CAS R-R	8610 (2)	5417D	

MCA

521	2T C-C	5205/5205D	5225	5212
-----	--------	------------	------	------

PENTAGON

C-1	2T C-C	5221D	5201D	
C-4	4T C-C	5413D	5411D	
C-8	8T 1/4" MAS - 42	5847/5848	5845/5846	
C-8	8T 1/4" SL - 42		5845/5846	
C-32	2T C-C	5221D	5201D	
C-34	4T C-C	5413D	5411D	
C-100	2T C-C	5221D	5201D	
C-120	2T C-C	5205/5205D	5201/5201D	
C-140	4T C-C	5413/5413D	5411/5411D	
C-320	2T C-C	5205/5205D	5201/5201D	
C-340	4T C-C	5413/5413D	5411/5411D	
C-400	4T C-C	5413D	5411D	
C-1000	2T 1/4" R-C	9210/9206D	5201/5201D	

Nortronics Tape Head Replacements for: Duplicators/Copiers

NOTE: "D" indicates long life Duracore Heads.

Model No.	Track Style & Ref. Notes	Master Play Head & QK	Slave Record Head & QK	Erase Head
PENTAGON (Continued)				
C-1320	2T 1/4" R-C-C	9210/9206D 5205/5205D	5201/5201D	
C-1323	2T 1/4" RR-CC	9210/9206D 5205/5205D	9203/9203D 5201/5201D	
C-1343	4T 1/4" RR-CC	5606 5413/5413D	5604 5411/5411D	
C-1400	4T 1/4" R-C	5606	5411/5411D	
C-5400	4T 1/2" R-C	9468	5411/5411D	
CC-1120	2T C-C	5221D	5201D	
CC-1140	4T C-C	5413D	5411D	
CM-1200	2T C MAS	5205/5205D		
CM-1400	4T C MAS	5413/5413D		
CM-2000	2T C MAS	5205/5205D		
CM-4000	4T C MAS	5413/5413D		
CS-420	2T C SL		5201/5201D	
CS-440	4T C SL		5411/5411D	
CS-1120	2T C SL		5201D	
CS-1140	4T C SL		5411D	
RC-1120	2T 1/4" R-C	9210/9206D	5201	
RC-1140	4T 1/4" R-C	5606	5411D	
RCC-1120	2T 1/4" RC-C	9210/9206D 5221D	5201D	
RCC-1140	4T 1/4" RC-C	5606/5413D	5411D	
RM-1120	2T 1/4" R-MAS	9210/9206D		
RM-1140	4T 1/4" R-MAS	5606		
RM-1200	2T 1/4" R MAS	9210/9206D		
RM-1400	4T 1/4" R MAS	5606		
RME-2210	2T 1/4" R MAS	9210/9206D		
RME-2410	4T 1/4" R MAS	5606		
RME-2810	8T 1/4" R MAS	5840		
RME-2850	8T 1" R MAS	9886		
RMT-2250	2T 1/4" R MAS	9210/9206D	9203/9203D	
RMT-4250	4T 1/4" R MAS	5606	5604	
RS-1120	2T 1/4" R SL	9203/9203D	5201/5201D	
RS-1140	4T 1/4" R SL	5604	5201/5201D	
RS-1200	2T .15" R SL		5201/5201D	
RS-1210	2T .15" R SL		5201/5201D	
RS-1400	4T .15" R SL		5413/5413D	
RS-1410	4T .15" R SL		5413/5413D	
RS-2150	2T .15" R SL		5201/5201D	
RS-2210	2T .15" R SL		5201/5201D	
RS-2250	2T 1/4" R SL		9203/9203D	
RS-2400	4T 1/4" R SL		5604	
RS-2410	4T 1/4" R SL		5604	
RS-2810	8T 1/4" R SL		5841	
RS-2818	8T 1/4" R SL		5841	
RS-4150	4T .15" R SL		5413/5413D	
RS-4250	4T 1/4" R SL		5604	
S-140	4T C SL		5411/5411D	
S-1000	2T C SL		5201/5201D	
S-1400	4T C SL		5411/5411D	
SCC-2150	2T C-C	5205/5205D	5201/5201D	
SCC-4150	4T C-C	5413/5413D	5411/5411D	
SRCC-2250	2T 1/4" R-C-C	9210/9206D 5205/5205D	5201/5201D	
SRCC-4250	4T 1/4" R-C-C	5606 5413/5413D	5411/5411D	

RAWDON-SMITH (MULTITAPE)

10HHN Dup.	2T R-R	9206/9206D	9203/9203D	
1214	FT R-R	9109/9109D	9103/9103D	
1215	2T 1/4" R-R	9206/9206D	9203/9203D	

Model No.	Track Style & Ref. Notes	Master Play Head & QK	Slave Record Head & QK	Erase Head
RAWDON-SMITH (MULTITAPE) (Continued)				
1224	FT R-R	9109/9109D	9103/9103D	
1225	2T 1/4" R-R	9206/9206D	9203/9203D	
1225	4T 1/4" R-R	5606	5604	
3421	2T C-C	5205/5205D	5201/5201D	
3422	2T C-C	5205/5205D	5201/5205D	

RECORDERX

CS-200	2T C-C	5206	5201/5201D	
CS-203	2T C-C	5205/5205D	5201/5201D	5214
CS-403	4T C-C	5413/5413D	5411/5411D	5214
CS-2000	2T C-C	5206	5201/5201D	
CS-2500	2T C-C	5205/5205D	5201/5201D	5214
CS-4000	4T C-C	5410/5410D	5411/5411D	
DUP I	4T C-C	5413/5413D	5411/5411D	5214
DUP II	2T C-C	5205/5205D	5220/5220D	5214
GT 2A	2T 1/4" RM	9206/9206D+38		
GT 2AS	2T 1/4" R SL		9204/9204D-38	
GT 4A	4T 1/4" RM	8610+38		
GT 4AS	4T 1/4" R SL		8604+38	
SUPER PRO 30	2T C-C	5205/5205D	5220/5220D	5214
SUPER PRO 30	4T C-C	5413/5413D	5411/5411D	5214

TAD (See GRINDLEY)

TELEX

COPIER I	2T CM-C	5223	5224D	5214
COPIER II	2T C SL		5224D	5214
COPIER IV	4T CM-C	5415	5414D	5214
COPIER V	4T C SL		5414D	5214
ECON. COP.	2T CM-C	5223	5224D	
300				
86476	2T 1/4" RM-C	9206/9206D	5201/5201D	5213
300				
86835	4T 1/4" RM-C	5606	5411/5411D	5213
300				
87113-03	2T CM-C	5205/5205D	5201/5201D	5213
300				
87113-06	4T CM-C	5413/5413D	5411/5411D	5213
300				
86781	2T 1/4" RM-R	9206/9206D	9203/9203D	
300				
86782	FT 1/4" RM-R	9109/9109D	9103/9103D	
235	4TS 1/4" RM-R	8606	8603	
235	4CH 1/4" RM-R	5602	5604	
235	2T 1/4" RM-R	9211/9211D	9203/9303D	
235	FT 1/4" RM-R	9110/9110D	9103/9103D	
235	2T C-C	5206	5201/5201D	

WOLLENSAK - 3M

1520 AV	2TM R-R	RPE-22		
2750 AV	2T CAS MAS	5205/5205D		
2760 AV	2T C SL		5201/5201D	
2270 AV	2T C MAS	5221/5221D		
2780 AV	2T C SL		5220/5220D	
6030 AV	2T 1/4" R MAS	9206/9206D		



Nortronics Tape Head Replacements for: Specialized Audio

This section covers those unique applications such as aircraft recorders, reverberation units, telephone answering systems, etc. Listing is by manufacturer's machine model number. See also Section E.

SECTION D

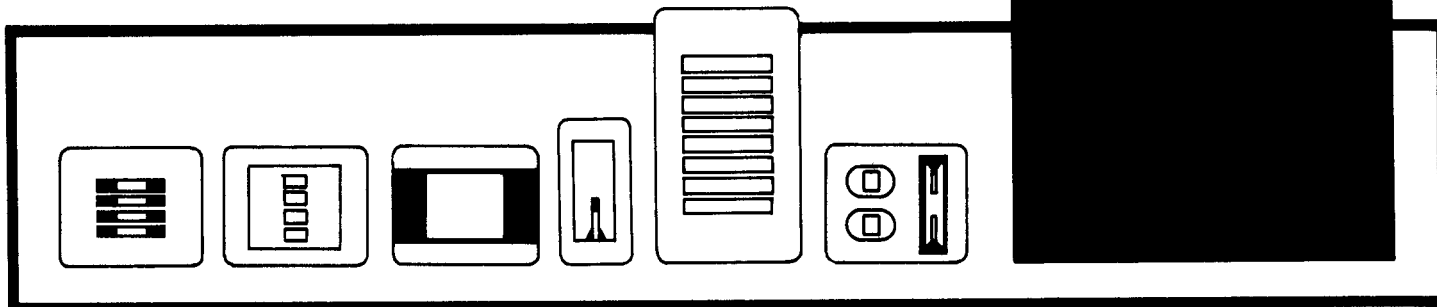

Model No.	Track Style & Ref. Notes	RP or RPE	4th Head or Combo	Record Head & QK	Playback Head & QK	Erase Head & QK
AMEGA (RANGERTONE) (16-mm Film Recorder)						
Up to 1973	200-mil - 48			9105	9111	8104
After 1973	200-mil - 48			9109	9109	8104
COLLINS (Cockpit Recorder)						
642C-1	4CH 1/4" CART			5613/ BQQ4R	5614/ BQQ4L	4408
ECHOPLEX (MAESTRO, GIBSON, SIREKO) Reverb.						
EM-1	2TM S.S.			6183	7456	
EP-2	2TM Tubes			6179	7456	
EP-3	2TM S.S.			6183	7456	
ES-1	2TM S.S.			6183	7456	
FAIRCHILD (Cockpit Recorder)						
A-100	4CH 1/4" CART			5611/ BQQ4R	5612/ BQQ4L	4408
GABLES (Airline Music Player)						
G285	2TM				7466	
G1225	4TS				7658	
LOCKHEED AIRCRAFT SERVICE						
Flt. Rec.	4CH 8TR			7609		

Model No.	Track Style & Ref. Notes	RP or RPE	4th Head or Combo	Record Head & QK	Playback Head & QK	Erase Head & QK
MOVIOLA/MAGNASYNC (Film Editors and Recorders) (See Section E for Part No. Cross Reference)						
LVR-M						4955
M50M						4955
M77						7413
M79						4955
M84						7413
M85						7413
M86						7413
MS16						7411
MS35						7411
SC20						7411
SD20						7411
SK20						7411
SL20						7411
SRC						7411
SRM						7411
UD-20S						7411
UL-20S						7411
3000					7425	7426 7723
SHOWCHRON (HONEYWELL) (Film Editor)						
16-1P-2S	2TM - 47					7402 (Pict.) 7427 (S1 & S2)
SUNDSTRAND (UNITED CONTROL) (Cockpit Recorders & Music Players)						
ATA	4TS					7602
CAM I	4TS					7602
CAM II	4TS					7602
CAM 202	4TS					5610
200 Series	4TS					5610
400 Series	4CH					5610
AV-557B	4CH 8 TR				5832	

Cross Reference

Recorder Manufacturer and/or Head Manufacturer's
Part Number to Nortronics Replacement Head & Quik-Kit

This section lists head part numbers used by the recorder manufacturer cross-referenced to available Nortronics replacements. In cases where no replacement is possible, the word "NONE" appears in the replacement column. The letters "NSI" in this column indicates that our files do not contain sufficient information to make a head and/or Quik-Kit replacement recommendation.

SECTION E

1. Locate Recorder Manufacturer listed alphabetically.
2. Find exact head number listed alphabetically/numerically.
3. Replacement head and QK Mount, if required, is listed horizontally in adjacent column.

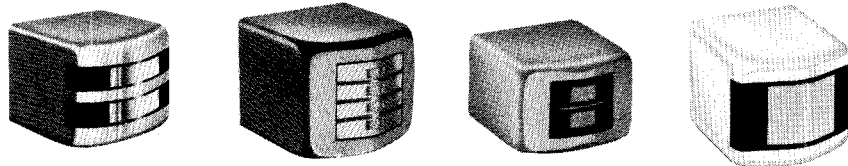

AMPEX	Head & QK
0296170-01	9202+87
0296170-02	9203+87
0296170-03	9223+87
0296170-07	9204+87
0296170-08	9211+87
0296192-01	9102+87
0296192-02	9103+87
0296192-03	9125+87
0296640-01	8600+87
1231757-01	9202+76
1231888-01	9472
1232357-01	9125+86
1232358-01	9103+86
1232359-01	9111+86
1232360-01	9222+86
1232361-01	8401+86
1232362-01	8403+86
1232363-01	9608+86
1232363-02	8604+86
1232363-03	8640+86
1815108-01	9111+87
1815108-02	9104+87
1815109-01	9125+87
1815110-01	9213+87
1815110-02	9203+87
1815111-01	9222+87
1815112-01	8600+87
1815112-02	8604+87
1815112-03	8708+87
1815112-04	8600+87
1815112-05	8605+87
4020228-01	8600+87
4020228-02	8604+87
4020228-03	8701+87
4020284-01	5607
4020285-01	5605
4040076-04	9202+66
4040076-05	9203+66
4040076-06	9223+66
4040084-10	9125+66
4040084-20	9103+66
4040084-30	9102+66
4040084-40	9223+66
4040084-50	8401+66
4040084-60	8400+66
4040323	8701+86
4040324	8604+86
4040325	8600+86
4040426-01	9125+76
4040437-01	9202+76
4040437-02	9203+76
4040437-05	9204+76
4040437-06	9209+76
4040438-51	8400+76
4040438-52	9102+76
4040438-63	9127+76
4040438-64	9125+76
4040438-66	8414+76
4040438-67	9104+76
4040438-68	9109+76
4040558-01	9464
4040558-02	9465
4040558-04	9465
4040558-05	9464
4040564-01	9472
4040684-03	9202+66
4040684-04	9203+66
4040684-05	9223+66
4040684-06	9125+66
4040684-07	9103+66
4040684-08	9102+66
4040684-09	9223+66
4040684-11	8400+66
4040684-12	8401+66
4040737-10	8607+86

AMPEX (Continued)	
4040738-10	1407+86
4040829-01	9127+76
4040829-02	9127+79
4040831-02	9227+79
4040837-01	9222+76
4045042-20	8607+86
4045043-10	8607+86
4350037-01	8609+76
7040015-20	8607+86
7040030	8607+86
7040161-01	8607+86
7040224-01	1203+86

AMPRO (INSTATAPE)	
8209	6103+66
8210	2001+66
9085-1	5710
9086-1	2010
9102-1	5701
9103-1	2001

ATC (GATES) (HARRIS)	
20-1001 Pro	3251
20-1001 Cue	3250
20-1010	3251
20-1011	2057
20-1014	2053
20-1015	5757
20-1016	5753
20-1017	2051

AUTOMATIC ELECTRIC (ELECTRONIC SECRETARY)	
WW3253-44	7406+21
WW4430-44	7406+21
WW4446-44	3606+19
WW5392-44	7406+21
WW6804-44	2600
WW6896-44	3200+21
WW7222-44	7406+21
WW8086-44	G1HY5L8-B
WW9454-44	6128

BROADCAST ELECTRONICS (See SPOTMASTER)	
4040437-02	9203+76
4040437-05	9204+76
4040437-06	9209+76
4040438-51	8400+76
4040438-52	9102+76

BRUSH (CLEVITE)	
BK-1065	8403+35
BK-1072	9213+35
BK-1072E	8301+35
BK-1072R	9203+35
BK-1090	8403+35
BK-1091	8400+35
BK-1110	8501+35
BK-1250	9103+35
BK-1251	9102+35
BK-1252	8102+35

CODE-A-PHONE (FORD)	
L03-011	7406
L03-012	NONE
L03-013	NONE
L03-014	2001

CODE-A-PHONE (Cont'd.)	
L03-015	4400
L03-018	6131
L03-021	6131
L03-025	6302
L03-033	2200
L03-039	6302
L03-041	6131

COLLINS	
020-8000-010	5703
020-8000-020	5707
020-8000-030	2007
020-8000-040	2003
020-8003-010	5602
235-0012-000 Pro	3251
235-0012-000 Cue	3250
235-0412-000	3251
235-0413-000	3251
270-2250-000	2053
270-2251-000	1251
270-2271-010	9105
270-2271-020	P-B1HC4K
270-2299-010	4401+19
270-2299-020	5613
270-2299-030	5614

CONCERTONE	
BD-35	1200+106
BH-1	4400+304
BH-3	9105+106
BH-6	2600+106
BT-2	1400+304
BT-282	1400+304
BT-3	9105+106
BT-4	1203+106
BT-6	1200+106
BT-22	1400+304
BT-66	2600+106
ND51	1202
ND52	1207
ND83	NONE
THP-102	2601+87
THP-204	1200+84
0113	1402+19
0342	1203+66
04-0014	1401+19
04-0015	1203+66
04-0016	1201+66
04-0055	1408+18
04-0056	1203
04-0057	1202
33T	1203+106
951	2603+83
3754	1200+66
3758	1200+66
10124	2600
105230	4400+304
105231	9105+106
105232	9111+106
105233	3600+304
105234	2603+106
105235, (-1)	2600+106
105236, (-1)	3600+304
105237	1200+106
105238	1203+106
105239	1203+106
105240	2003+106
105241	2000+106
105242	1400+304
105243	1400+304

CONCERTONE (Cont'd.)	
105244	1400+304
105246	1400+304
105247	NONE
105248	NONE
106120	3600+304
106121	4400+304
106122 (-2)	2610+106
106123 (-2)	2010+106
106124	2600+106
106125	2000+106
106126 (-1, -2)	9103+106
106390	9111+106
106438	1200+106
108046	4403+304
108145	2002+106
108245	2002+106
135234	2603
400067	NONE
400068	NONE
700071-1	1200+84
700086-1	8708+84
700087-1	1203+84
700539	8640+66
700543	1210+66
700544	8600+66
700545	8200+66
700547	9226+66
700548	2010+66
700682 RECORD	9105+66
700682 PLAY	9111+66
700683	9128+66

CROWN INTERNATIONAL	
ASQ3K	1201+66
ASQ4R	1203+66
SLA3L	2601+66
TLB3	1201+66
1189	6101+66
1190	9103+66
1191	8404+66
1192	9103+66
1193	8608+66
1194	8406+66
1195	8406+66
1196	3601+19
1197	6004+66
1198	8204+66
1200	8603+66
1201	8106+66
1202	9111+66
1203	9213+66
1204	1401+19
1205	5604+66
1206	5602+66
1207	5603+66
1208	3600+19
1209	9222+66
1210	NONE
1211	NONE
1212	NONE
1621	8209+66
1631	9222+66
1690	8209+66
1705	9111+66
1716	8403+66
1763	8601+66
1785	8201+66
1786	NONE
1787	NONE
1788	NONE
1789	5604+66
1790	5603+66
1799	1200+66

D

E

Cross Reference

Recorder Manufacturer and/or Head Manufacturer's Part Number to Nortronics Replacement Head & Quik-Kit

TELEX (MAGNECORD) (VIKING) (Continued)		TELEX (MAGNECORD) (VIKING) (Continued)		TELEX (MAGNECORD) (VIKING) (Continued)		TELEX (MAGNECORD) (VIKING) (Continued)	
	Head & QK						
55025	NONE	55127	1250	55230	3600+19	55333	3202
55026	2250	55128	1250	55231	1250	55334	2000
55027	2000+66	55129	1200	55232	1252	55335	3201
55028	1200+66	55130	1250	55233	1203	55336	2005
55029	1400+19	55131	1250	55234	1203	55337	2251
55030	NONE	55132	1202	55235	5603	55338	3202
55031	NONE	55133	1202	55236	5602	55339	3202
55032	2200+19	55134	1202	55237	5653	55340	2052
55033	NONE	55135	1201+66	55238	1203	55341	3200
55034	2002	55136	1201	55239	1201+19	55342	3200
55035	1203	55137	7406+21	55240	3601L	55343	3200+21
55036	2005	55138	4450	55241	2201+19	55344	1202+66
55037	NONE	55139	3101	55242	2251	55345	3251
55038	3250	55140	4450	55243	2201L	55346	3200+21
55039	1250	55141	4400L	55244	1451	55347	3200+21
55040	1450	55142	1200	55245	3250	55348	7406+21
55041	2050	55143	3600+19	55246	3203	55349	3202+21
55042	NONE	55144	3600+19	55247	3251	55350	3202+21
55043	2200+19	55145	NONE	55248	9111+66	55351	2052
55044	3201+21	55146	2000	55249	9110	55352	3201
55045	3000+21	55147	2005	55250	3051	55353	1201
55046	1400+19	55148	1200	55251	2001+66	55354	3200
55047	3600+19	55149	1205	55252	2052	55355	1205
55048	3600+19	55150	9111	55253	1400+19	55356	2005
55049	3600+19	55151	4400+19	55254	1200	55357	2003
55050	1401+19	55152	9111+66	55255	2000	55358	3205
55051	1201	55153	1450	55256	1200	55359	3203
55052	3650	55154	1200+66	55257	1205	55360	1200
55053	1202	55155	1200+66	55258	2201+19	55361	1203
55054	1401L	55156	1400+19	55259	3002	55362	2002
55055	2201+19	55157	1400+19	55260	3001	55363	4401L
55056	2201+19	55158	1200	55261	1205	55364	3201
55057	3251	55159	1400L	55262	1401+19	55365	3601L
55058	3000	55160	1200	55263	3201	55366	3203
55059	NONE	55161	1251	55264	3201	55367	9105
55060	2001+66	55162	3255	55265	2201L	55368	2002
55061	NONE	55163	1255	55266	1200+66	55369	2010
55062	3200	55164	1252	55267	1400L	55370	1210
55063	3200	55165	2201L	55268	1201+66	55371	P-G1H8R
55064	3200+21	55166	2051	55269	1200+66	55372	1202
55065	3001+21	55167	5651	55270	1200+66	55373	9110
55066	3250	55168	5653	55271	2000	55374	2051
55067	3250	55169	2002	55272	2005	55375	3051
55068	3250	55170	7406+21	55273	2200L	55376	2053
55069	3201	55171	3601+19	55274	3202	55377	2001+66
55070	3201	55172	2200+19	55275	1400L	55378	2021+66
55071	3201+21	55173	3202	55276	4450	55379	5602
55072	3201+21	55174	3201	55277	3251	55380	5751
55073	3201+21	55175	3250	55278	3202+21	55381	5752
55074	3201+21	55176	3201+21	55279	2200L	55382	2003
55075	3251	55177	3201+21	55280	1401L	55383	1201-66
55076	3201+21	55178	3251	55281	NONE	55384	1201-66
55077	3201	55179	3205+21	55282	1201	55385	1401+19
55078	CH3R	55180	3201	55283	1202	55386	5653
55079	9111	55181	3201	55284	3200	55387	NONE
55080	9161	55182	1201+66	55285	1205	55388	9103
55081	9161	55183	1202	55286	3205+21	55389	NONE
55082	3200	55184	1202+66	55287	1202+66	55390	1252
55083	3250	55185	1200	55288	1221	55391	2052
55084	3200+21	55186	1201+66	55289	1203	55392	2251
55085	3200+21	55187	1251	55290	2005+66	55393	3102
55086	3205	55188	1201+66	55291	5601	55394	6000
55087	3251	55189	1203+66	55292	2200L	55395	PA2H17R-R
55088	3251	55190	4450	55293	3600L	55396	6180
55089	3201	55191	3600+19	55294	1400L	55397	NONE
55090	3251	55192	3600L	55295	4400L	55398	PA2H17K-R
55091	3202+21	55193	3601+19	55296	2003	55399	5602+66
55092	3202+21	55194	1401L	55297	3200	55400	1257
55093	3252	55195	2200L	55298	1451	55401	1251
55094	3202+21	55196	2200L	55299	1400L	55402	1221
55095	3202+21	55197	2200+19	55300	1400+19	55403	3202
55096	3202	55198	2250	55301	7406+21	55404	3252
55097	1200	55199	2201L	55302	3600+19	55405	1251
55098	1202	55200	2201L	55303	1200+66	55406	PA1Q17K-R
55099	1202+66	55201	2201L	55304	2000+66	55407	5604
55100	1202+66	55202	1400L	55305	2200+66	55408	2050
55101	1202+66	55203	1450	55306	2052	55409	3651
55102	1250	55204	1450	55307	3251	55410	A2Q22K-R
55103	2000	55205	1401L	55308	2002	55411	1201
55104	2005	55206	1400+19	55309	3202	55412	3102+21
55105	2050	55207	1401+19	55310	2001	55413	3202+21
55106	2005	55208	1401+19	55311	1257	55414	1207
55107	2051	55209	1401L	55312	1002	55415	3252
55108	2002	55210	2050	55313	2051	55416	3252
55109	2052	55211	2051	55314	1200+66	55417	9111
55110	2003	55212	2051	55315	1200+66	55418	2053
55111	1200	55213	1250	55316	1200+66	55419	3251
55112	1200+66	55214	1200	55317	3202+21	55420	2005
55113	1201	55215	1202+66	55318	3202+21	55421	2001
55114	1201+66	55216	1207	55319	3601+19	55422	7406
55115	1202	55217	3202	55320	7406+21	55423	1201+66
55116	1203	55218	2002	55321	2002	55424	A2Q44K-R
55117	1203+66	55219	3600+19	55322	6103	55425	PA1HC17K-R
55118	1202+66	55220	3600+19	55323	2603	55426	9103
55119	1202+66	55221	3600+19	55324	1201+66	55427	2010
55120	1205	55222	2200+19	55325	1202	55428	1210
55121	1200	55223	2200+19	55326	3200	55429	5800
55122	1250	55224	2200+19	55327	1201+66	55430	6153
55123	1202+66	55225	2201+19	55328	1201+66	55431	3201+21
55124	1202+66	55226	1400+19	55329	1257	55432	3201+21
55125	1201	55227	1400+19	55330	3200	55433	3201+21
55126	1202+66	55228	1401+19	55331	3202	55434	3201+21
		55229	1400+19	55332	3202	55435	3201+21

"L" is Duracore

Cross Reference

Recorder Manufacturer and/or Head Manufacturer's
Part Number to Nortronics Replacement Head & Quik-Kit

TELEX (MAGNECORD) (VIKING) (Continued)	Head & QK
55436	1201+66
55437	1201+66
55438	1202+66
55439	1202+66
55440	3201
55441	3202
55442	3601+19
55443	3253
55444	9160
55445	4451
55446	3600+19
55447	3253
55448	1401+19
55449	1202
55450	7406+21
55451	3202+21
55452	1202+66
55453	3201+21
55454	3205+21
55455	2001+66
55456	1205+66
55457	3202+21
55458	1202+66
55459	3203+21
55460	2002+66
55461	1203+66
55462	1205
55463	2003
55464	1203
55465	3203
55466	1202
55467	3205
55468	1257
55469	2052
55470	1250
55471	1250
55472	2051
55473	1207
55474	NONE
55475	1207
55476	5652
55477	1202
55478	5701
55479	1251
55480	2051
55481	2056
55482	6151
55483	3001
55484	1255
55485	6153
55486	2060
55487	7406+21
55488	1253
55489	2002
55490	A2H17K-R
55491	3201+21
55492	PA2Q47K-R
55493	2002+66
55494	PA2Q44K-R
55495	2000
55496	1251
55497	1251
55498	NONE
55499	NONE
55500	3201+21
55501	3201+21
55502	1221+66
55503	3253
55504	6180
55505	3251
55506	1257
55507	3251
55508	5751
55509	1201+66
55510	1203+66
55511	9111+66
55512	3251
55513	6152
55514	3201+21
55515	1251
55516	1202+66
55517	1251
55518	2002
55519	A1HC44R-R
55520	5853
55521	5652
55522	7468
55523	1200
55524	1201
55525	2000
55526	1252
55527	7406+21
55528	3250
55529	7406
55530	3252+21
55531	6126+66
55532	6153
55533	6151
55534	6002
55535	PA2Q42K-R
55536	PA2Q42K-R
55537	1253

TELEX (MAGNECORD) (VIKING) (Continued)	
55538	1257
55539	1222
55540	3201
55541	2050
55542	2007
55543	1201
55544	1202+66
55545	2002
55546	3255
55547	2001
55548	2052
55549	3201
55550	7406+21
55551	5800
55552	5850
55553	1002+66
55554	8210
55555	3251
55556	1202+66
55557	1202+66
55558	8400
55559	7406+21
55560	5835
55561	5651
55562	2055
55563	3201+21
55564	3201+21
55565	1202
55566	9105
55567	2007
55568	3201
55569	5757
55570	1260
55571	2602
55572	3202
55573	3202+66
55574	5813
55575	5603
55576	2050
55577	PA2H17K-R
55578	2203+19
55579	7406
55580	1251
55581	2055
55582	2001
55583	9211
55584	5604
55585	5602
55586	5834
55587	1252
55588	9228
55589	9204
55590	9202
55591	NONE
55592	NONE
55593	NONE
55594	1252
55595	6055
55596	3252
55597	1202
55598	3201
55599	2021
55600	1250
55601	2000+66
55602	1251
55603	1200+66
55604	7406
55605	9161
55606	2055
55607	2060
55608	3251
55609	1257
55610	9160
55611	NONE
55612	3251
55613	2007
55614	3201+21
55615	1202
55616	1210
55617	5652
55618	2053
55619	2057
55620	1260
55621	1253
55622	5201
55623	2053
55624	1402
55625	1402+19
55626	5654
55627	NONE
55628	5685
55629	5683
55630	5652
55631	3250
55632	2602
55633	6200
55634	1201
55635	5850
55636	3252
55637	5411
55638	5411
55639	1257
55640	5130

TELEX (MAGNECORD) (VIKING) (Continued)	
55641	5200
55642	NONE
55643	NONE
55644	NONE
55645	NONE
55646	5602
55647	NONE
55648	5206
55649	5410
55650	PR-B2H14N
55651	5230A
55652	5213
55653	5213
55654	5213
55655	3150
55656	9228
55657	9203
55658	9213
55659	2203
55660	1251
55661	NONE
55662	5220
55663	8602
55664	8607
55665	8702
55666	8203
55667	8202
55668	8302
55669	9112
55670	8102
55671	8408
55672	5223
55673	5211
55674	5833
55675	5802
55676	NONE
55677	6201
55678	5211
55679	5232
55680	7421
55681	5210
55682	5410
55683	5201
55684	NONE
55684	NONE
55685	NONE
55686	NONE
55687	8210
55688	NONE
55689	NONE
55690	NONE
55691	2004
55692	8614
55693	8202
55694	NONE
55695	NONE
55696	NONE
55697	NONE
55698	NONE
55699	NONE
55700	NONE
55701	NONE
55702	NONE
55703	2001
55704	5411
55705	5410
55706	NONE
55707	NONE
55708	NONE
55709	NONE
55710	NONE
55711	NONE
55712	NONE
55713	NONE
55714	NONE
55715	8601
55716	8208
55717	8406
55718	6201
55719	NONE
55720	NONE
55721	NONE
55722	NONE
55723	NONE
55724	NONE
55725	NONE
55726	NONE
55727	NONE
55728	5230A
55729	5800
55730	5424D
55731	5415
55732	6004
55733	5603
55734	5230A
55735	5230A
55736	NONE
55737	NONE
55738	NONE
55739	NONE
55740	8304
55741	5800
55742	7605D

TELEX (MAGNECORD) (VIKING) (Continued)	
55743	8208
55744	1271D
55745	5703D
55746	5701D
55747	2003D
55748	2001D
55749	NONE
55750	5800
55751	5224D
55752	5201D
55753	5424D
55754	5411D
55755	NONE
55756	6101
55757	9202

TELEX (VIKING) (MAGNECORD)	
A36B106-1	9103+35
A36B107-1	9102+35
A36B117-1	9112
A36C119-1	8102
A91D8784-1	8602+74
A91D8784-2	8607
A91D8784-3	8203
A91D8784-4	9207
A91D8784-17	8702
A91D8784-20	8302
A91D8784-23	8102
A91D8784-26	9214
A91D8784-27	1204
AN291	5601
AN322	6103
EBB157	1400+19
EFN141	4400L
EFN295	4400L
EFN363	4401L
EFR140	4450
EFR276	4450
EHB143	3600+19
EHB144	3600+19
EHB302	3600+19
EHN11	3600L
EHN293	3600L
EHN365	3601L
EHR23	3650
EMB156	1400+19
EMB157	1400+19
EMB253	1400+19
EMN159	1400L
EMN299	1400L
EMR253	1450
EQB29	1400+19
EQB46	1400+19
EQB262	1401+19
EQB300	1400+19
EON15	1400L
EON267	1400L
FQN275	1400L
EQN280	1401L
EQN294	1400L
EQR40	1450
ESB32	2200+19
ESB258	2201+19
ESB305	2200+19
ESN13	2200L
ESN265	2201L
ESN273	2200L
ESN279	2200L
ESN292	2200L
ESR26	2250
ESR298	2251
ESR337	2251
FB152	9111+66
FN18	9111
FN82	2600
FN150	9111
FN367	9105
FR80	9161
HB139	3101+21
HB286	2603+66
HB301	2000+21
HB317	2602+66
HB318	2602+66
HB320	7401
HB332	2602
HB333	2602
HB342	3101+21
HB343	3202+21
HB346	3100+21
HB347	3002+21
HB348	3101+21
HB349	3202+21
HB350	3202+21
HN63	3000
HN69	3001
HN82	2600

"L" and "D" are Duracore heads.



Cross Reference

Recorder Manufacturer and/or Head Manufacturer's
Part Number to Nortronics Replacement Head & Quik-Kit

TELEX (VIKING) (MAGNECORD) (Continued)	Head & QK
HN89	2600
HN259	3002
HN263	3001
HN264	3001
HN274	2602
HN278	2601
HN284	2600
HN297	2600
HN309	3002
HN316	3000
HN323	2603
HN326	3000
HN330	3200
HN331	3202
HN335	2601
HN338	3002
HN339	3001
HN341	3000
HN352	3201
HN354	3200
HN358	3205
HN359	2603
HN364	3201
HN366	3203
HR22	3250
HR90	3051
HR250	3051
HR277	3051
HR307	3051
HR345	3051
M122	1250
MB154	1000+66
MB155	1000+66
MB344	1202+66
MN51	1201
MN158	1200
MN160	1000
MR122	1251
QB131	1001+66
QB142	1000+66
QB266	1200+66
QB268	1201+66
QB269	1200+66
QB270	1200+66

TELEX (VIKING) (MAGNECORD) (Cont'd)	
QB281	1201+66
QB282	1201+66
QB283	1202+66
QB287	1202+66
QB303	1200+66
QB314	1200+66
QB315	1200+66
QB324	1201+66
QB327	1201+66
QB328	1201+66
QN129	1200
QN132	1205
QN148	1200
QN149	1205
QN256	1200
QN257	1205
QN261	1205
QN282	1201
QN283	1201
QN288	1221
QN289	1203
QN312	1202
QN325	1202
QN355	1205
QN360	1200
QN361	1203
QN370	1210
QN372	1202
QR127	1250
QR311	1251
QR329	1251
SB27	2000+66
SB251	2001+66
SB290	2005+66
SB304	2000+66
SN103	2000
SN106	2005
SN146	2000
SN147	2005
SN255	2000
SN271	2000
SN272	2005
SN296	2003
SN308	2002
SN310	2001

TELEX (VIKING) (MAGNECORD) (Cont'd)	
SN321	2002
SN334	2000
SN336	2001
SN356	2005
SN357	2003
SN362	2002
SN368	2002
SN369	2010
SR21	2050
SR306	2052
SR313	2051
SR340	2052
SR351	2052
4A91A941	8403+75
4A91A942	8403+75
36C111	8602
36C112	8607
36C113	8702
36C114	8203
36C115	9207
36C116	8302
36C117	9112
36C118	9111
36C119	8102
36C141	2004
36C142	1204
36C143	8202
36C153	8202
75-G58	1401+19
75Q2	1200+66
75S2	2000+66
51628-000	2001
51628-001	2001
51628-002	5603
51982-001	5201
51982-002	7421
51982-003	5220
51982-004	5205
85545-01	6800
90076-000	5802
7298991	5802

WOLLENSAK (3M)	
78-8010-4492	7610
78-8473-8962	7610
26161-700	5221
27161-001	RPE-20
27161-010	RPE-20
27161-060	7601
27161-070	7722
27161-080	7722
27161-090	NONE
27161-100	NONE
27161-110	RPE-20
27161-130	7722
27161-140	7601
27161-180	RPE-20
27161-190	6125
27161-200	6026
27161-210	6002
27161-220	RPE-20
27161-221	RPE-20
27161-250	6005+66
27161-270	6128+66
27161-280	RPE-21
27161-281	RPE-21
27161-320	RPE-22
27161-380	6008
27161-410	5232
27161-450	5133
27161-460	RPE-22
27161-470	NONE
27161-510	6008
27161-520	1202
27161-540	5207
27161-570	5205D
27161-580	5201D
27161-590	W2ER6
27161-600	8210
27161-610	5212
27161-620	W1R25G
27161-690	5220D
27161-700	5221D
27161-860	5151

VIKING (See TELEX)

DURACORE® Heads

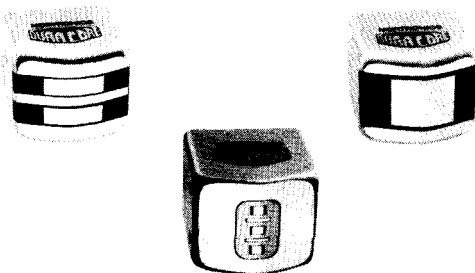

DURACORE REPLACEMENT TAPE HEADS FOR PROFESSIONAL RECORDERS

Professional recording equipment users need magnetic heads with greatly-extended wear life to directly reduce operational costs by eliminating electronic adjustments, requiring fewer service calls and cutting recorder downtime. Nortronics now offers a new series of direct replacement magnetic heads constructed with a new wear-resistant material called DURACORE. It provides ten times the operational lifespan of conventional Mu-metal replacements to yield meaningful cost advantages. More than three years of extensive testing have proved DURACORE to be the ideal material for long-life replacement heads. You'll find that DURACORE heads provide excellent wear resistance and they're also affordable. DURACORE replacements are currently available for popular professional reel-to-reel and cartridge recorders/payers manufactured by many well-known companies

Nortronics Magnetic Head Specifications

SECTION

F

These specifications cover the complete line of NORTRONICS replacement heads, listed in numerical order by their RCD (Recorder Care Division) Model No. Included are heads for use on the .150-inch cassette tape, 1/4-inch, 1/2-inch, 1-inch, and 2-inch tapes. Replacement heads for specific recorders. Write to Nortronics for a FREE dealer listing.

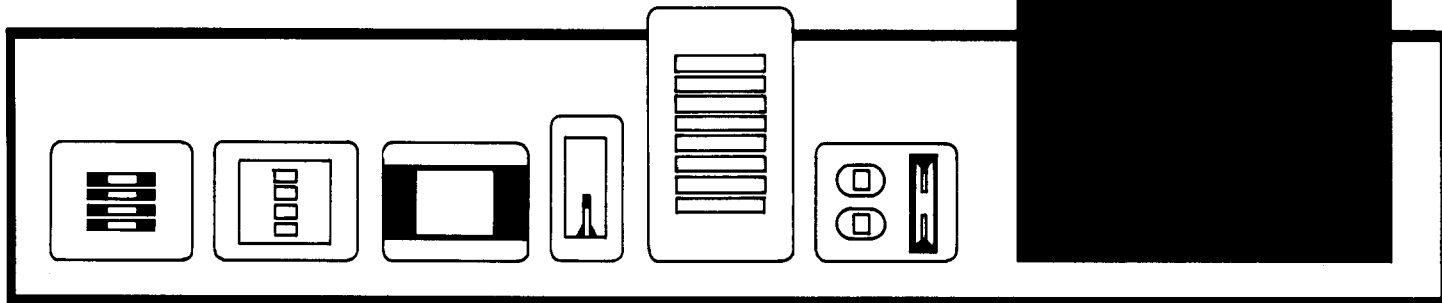

DURACORE – Nortronics pioneered this long-wearing core material which gives up to ten times the life of conventional permalloy. Heads available in DURACORE are indicated by the letter "D" after the Model No.

RECORD/PLAY PLAYBACK RECORD	MAGNETIC HEADS 1/4-INCH TAPE		RCD MODEL NO., NO MOUNT (*D* indicates DURACORE) (#Heads have mounts)	Outline Drawing & Case Size	Rear Mount NORTRONICS Head Model No.	Rear Mount Drawing No.	OEM NORTRONICS Head No. (*Rear Mount Head No.) (*LP* indicates DURACORE)	Head Function	Application Notes	Inductance, 1 kHz mH	Impedance, 1 kHz ohms	Resistance, D.C. ohms	Gap Spacer uIn	Crosstalk Rejection 1 kHz dB	7.5 IPS unequalized R/P response using 3M176 tape pk-biased at 1 kHz, 12 dB below tape saturation.					NRZ digital write/read data, 7.5 IPS, 200 BPI		
	Peak Bias I 100 kHz rms mA	Peak Bias V, 100 kHz rms V													Audio Record Current rms uA	1 kHz Play Output rms mV	10 kHz/A kHz Output Ratio dB	Write Current mA	Read Output 200 BPI mV	Max. Read Pack. Dens. BPI		
PREMIUM 4-track Stereo Heads B-size case, laminated cores, deposited gaps, hyperbolic faces. .043-inch (1.1-mm) tracks (2) .136-inch (3.45-mm) center-to-center track spacing.	1200	1B	1250	58	P-B2Q2K	RP	1	800	5000	750	100	50	0.20	75	25	2.5	+4	1.6	36	1600		
	1201	1B	1251	58	P-B2Q7K	RP	2	400	2600	400	100	50	0.3	67	30	1.6	+4	1.6	36	1600		
	1202	1B	1252	58	P-B2Q4K	R	2	100	700	100	100	50	0.7	30	65	.85	+3	3.1	24	1600		
	1203	1B	1253	58	P-B2Q4R	R	3	50	350	100	500	50	0.7	28	60	—	—	2.7	18	400		
	1204	1B	—	—	See #B614	—	—	—	—	—	—	—	—	—	—	—	—	—	—	—	—	
	1205	1B	1255	58	P-B2Q7R	R	3	230	1300	410	500	50	0.3	33	30	—	—	1.7	36	400		
	1207	1B	1257	58	P-B2Q6K	RP	2	200	1300	215	100	50	0.4	35	40	1.3	+3	2.2	26	1600		
	1210	1B	—	—	P-B2Q8R	R	4	10	70	32	500	50	2.0	7.5	130	—	—	6.2	9	400		
	1221	1B	1271	—	—	P-B2Q7F	P	6	500	3500	315	50	50	—	—	—	1.3	+4	—	—	—	
	1221D	1B	—	—	—	LP-B2Q7F	—	—	—	—	—	—	—	—	—	—	—	—	—	—	—	
	1222	1B	—	—	—	P-B2Q8F	P	5	20	130	24	50	50	—	—	—	0.3	+1	6.2	8	1600	
	PREMIUM 2-track Stereo Heads B-size case, laminated cores, deposited gaps, hyperbolic faces. .080-inch (2.0-mm) tracks (2) .160-inch (4.0-mm) center-to-center track spacing.	2000	20B	2050	58	P-B2H2K	P	1	800	5000	700	100	50	—	—	—	3.0	+5	1.3	72	1600	
2001		20B	2051	58	P-B2H7K	RP	2	400	2500	440	100	50	0.35	65	40	2.6	+5	1.8	48	1600		
2001D		20B	2051D	58	LP-B2H7K	—	—	—	—	—	—	—	—	—	—	—	—	—	—	—	—	
2002		20B	2052	58	P-B2H4K	RP	2	100	700	120	100	50	0.7	35	70	1.3	+3	3.6	24	1600		
2002D		20B	2052D	58	LP-B2H4K	—	—	—	—	—	—	—	—	—	—	—	—	—	—	—	—	
2003		20B	2053	58	P-B2H4R	R	3	50	340	120	500	50	0.65	20	80	—	—	3.4	24	400		
2003D		20B	2053D	58	LP-B2H4R	—	—	—	—	—	—	—	—	—	—	—	—	—	—	—	—	
2004		20B	—	—	P-B2H11R	R	4	1.5	10	4	500	50	6.0	4.5	470	—	—	20.0	6	400		
2005		20B	2055	58	P-B2H7R	R	3	200	1300	410	500	50	0.4	40	40	—	—	1.8	48	400		
2007		20B	2057	58	P-B2H6K	RP	2	200	1400	230	100	50	0.65	52	60	1.8	+4	2.7	36	1600		
2007D		20B	2057D	58	LP-B2H6K	—	—	—	—	—	—	—	—	—	—	—	—	—	—	—	—	
STANDARD 2-track Mono Heads G-size case, laminated cores, deposited gaps, hyperbolic faces. .080-inch (2.0-mm) single track. Located .020-inch (0.5-mm) below center on head face.	3100	19G	—	—	G1HY2K	RP	9	800	5000	390	100	—	0.4	100	30	3.4	-3	1.3	70	1600		
	3101	19G	—	—	G1HY5L	RP	9	440	2800	340	160	—	0.5	60	40	3.0	-3	1.5	55	800		
	PREMIUM 2-track Mono Heads G-Size case, laminated cores, deposited gaps, hyperbolic faces. .080-inch (2.0-mm) single track. Located .080 (2.0-mm) off center on head face. (Full offset, so head may be inverted to pickup other track.)	3200	18G	3250	58	P-G1H2K	P	1	800	5000	390	100	—	0.3	90	30	3.6	+5	1.3	72	1600	
		3201	18G	3251	58	P-G1H7K	RP	2	400	2600	160	100	—	0.3	70	40	2.6	+5	1.8	48	1600	
		3202	18G	3252	58	P-G1H4K	RP	2	100	700	70	100	—	0.7	35	70	1.3	+4	3.6	24	1600	
		3203	18G	3253	58	P-G1H4R	R	R	50	320	70	500	—	0.9	25	75	—	—	3.4	24	400	
	3205	18G	3255	58	P-G1H7R	R	R	200	1300	150	500	—	0.4	40	40	—	—	1.8	48	400		
Special Miniature single-channel heads. "L" are laminated, "M" solid core.	4950†	46L	4950	46L	L24R8L5-R*	RP	10	40	280	130	0.16	—	0.4	10	50	0.5	+2	2.2	8	800		
	4951†	46L	—	—	AL42R1L3-B4	P	11	425	2800	600	0.16	—	—	—	—	1.2	+3	—	—	—		
	4952†	46L	4952	46L	L42R8L-R*	RP	12	80	520	135	0.16	—	0.5	20	55	0.9	+3	3.1	18	800		
	4953†	49M	—	—	IM90E3U4-R*	E	13	—	—	—	—	—	—	—	—	—	—	—	—	—		
	4954†	49M	4954	49M	M70R4L4-R*	RP	14	20	150	80	0.16	—	0.3	20	125	0.7	0	15.0	12	800		
	4955†	50M	—	—	M70R5L6-B	RP	14	200	1500	700	0.16	—	1.0	50	40	2.1	+2	5.0	40	800		
4956†	50M	—	—	L42R5K65-B	RP	15	220	1500	250	0.1	—	0.4	35	35	1.0	+3	2.0	25	1600			

Magnetic Head Specifications

RECORD/PLAY PLAYBACK RECORD (Continued)	MAGNETIC HEADS 1/4-INCH TAPE												3.75 IPS unequalized R/P response using 3M176 tape pk-biased at 1 kHz, 12 dB below tape saturation.					NRZ digital write/read data, 7.5 IPS, 200 BPI		
	RCD MODEL NO., NO MOUNT (*LP* indicates DURACORE) (#heads have mounts)	Outline Drawing & Case Size	Rear Mount NORTRONICS Head Model No.	Rear Mount Drawing No.	OEM NORTRONICS Head No. (*LP* indicates DURACORE)	Head Function	Application Notes	Inductance, 1 kHz mH	Impedance, 1 kHz ohms	Resistance, D.C. ohms	Gap Spacer µin	Crosstalk Rejection 1 kHz dB	Peak Bias 1	Peak Bias V.	Audio Record	1 kHz Play	10 kHz/1 kHz	Write Current mA	Read Output 200 BPI µV	Max. Read Pack. Dens. BPI
													100 kHz rms	100 kHz rms	Current rms	Output rms	Output Ratio			
B-TRACK STEREO Heads for 1/4-inch Tape. Standard Models: .018-inch (.46-mm) Track Width (2) .127-inch (3.23-mm) C-C Track Spacing	5800	35B	5850	58	B2L7K L82L7K	RP	2	430	3000	730	100	50	0.3	35	16	.8	-9	1.2	18	1600
	5801	35BX	-	-	H899019	P	20	430	3000	800	100	50	0.3	35	16	.8	-9	1.2	18	1600
PREMIUM 8-TRACK Stereo heads with fine laminations for improved H.F. performance. .021-inch (.53-mm) Track Width (2) .127-inch (3.23-mm) C-C Track Spacing	5810	35B	-	-	P-B2L8R	R	4	10	70	35	500	50	1.3	5.5	90	-	-	4.0	6	400
	5811	35B	-	-	P-B2L7K	RP	2	450	3000	650	100	50	0.2	50	20	.8	-7	1.2	18	1600
	5813	35B	-	-	P-B2L4R	R	3	50	355	165	500	50	.45	10	40	-	-	1.8	10	400
4-CHANNEL 8-TRACK Heads for 1/4-inch tape. Two staggered heads may be used to generate all 8 tracks on the tape. .021-inch (.53-mm) Track Width (4) .0635-inch (1.62-mm) C-C Track Spacing	5832	36B	-	-	P-BQL6K	RP	2	200	1350	480	100	35	-	-	-	0.6	-9	1.6	14	1600
	5833	36B	-	-	P-BQL4K	RP	2	100	690	270	100	35	.55	25	45	0.4	-9	2.3	10	1600
	5834	36B	-	-	P-BQL4R	R	3	50	390	225	500	35	.75	30	60	-	-	2.3	10	400
	5835	36B	-	-	P-BQL8R	R	4	10	90	60	500	35	2	8.5	140	-	-	4.0	6	400
	5836	36B	-	-	P-BQL14R	R	4	2	20	15	500	35	3	3	300	-	-	8	4	400
	5837	36B	-	-	P-BQL7K	P	2	330	2300	760	100	35	-	-	-	.75	-9	1.2	18	1600
	5840	36B	-	-	PC-BQL8K	P	5	20	150	45	0.1	50	-	-	-	.15	-7	4	6	400
PREMIUM 4-CHANNEL 8-TRACK Heads for 1/4-inch tape. Two heads may be used for all 8 tracks. Incorporate better interchannel shielding for improved crosstalk rejection in duplicator applications. .021-inch (.53-mm) Track Width (4) .0635-inch (1.62-mm) C-C Track Spacing	5841	36B	-	-	PC-BQL8R	R	4	10	70	30	0.5	50	1.6	8	130	-	-	4	6	400
	5842	36B	-	-	PC-BQL6K	RP	2	200	1300	290	0.1	60	.55	35	35	.45	-7	1.6	14	1600
	5843	36B	-	-	PC-BQL14R	R	4	2	15	10	0.5	50	3.8	3.8	320	-	-	8	4	400
	5844	36B	-	-	PC-BQL4K	RP	2	100	700	130	0.1	50	.75	25	50	0.3	-7	2.3	10	1600
	5845	36B	-	-	PC-BQL8R-B35	R	23	10	70	30	0.5	50	1.6	8	130	-	-	4	6	400
	5846	36B	-	-	PC-BQL8R-B36	R	24	10	70	30	0.5	50	1.6	8	130	-	-	4	6	400
	5847	36B	-	-	PC-BQL8K-B35	P	23	20	150	45	0.1	50	-	-	-	.15	-7	4	6	1600
	5848	36B	-	-	PC-BQL8K-B36	P	24	20	150	45	0.1	50	-	-	-	.15	-7	4	6	1600

"COMBO" HEADS	ERASE-RECORD/PLAY												ERASE								
	RCD MODEL NO., NO MOUNT (*LP* indicates DURACORE) (#heads have mounts)	Outline Drawing & Case Size	Rear Mount NORTRONICS Head Model No.	Rear Mount Drawing No.	OEM NORTRONICS Model No. (*LP* indicates DURACORE)	Head Function	Application Notes	Inductance, 1 kHz mH	Impedance, 1 kHz ohms	Resistance, D.C. ohms	Gap Spacer µin	Crosstalk Rejection 1 kHz dB	7.5 IPS unequalized R/P response using 3M176 tape pk-biased at 1 kHz, 12 dB below tape saturation.	60 dB erasure from sat. 400 Hz recording 100 kHz supply							
													Peak Bias 1	Peak Bias V.	Audio Record	1 kHz Play	10 kHz/1 kHz	Inductance	Resistance	Current, rms	Volts rms
PREMIUM 4-Track Stereo "Combo" Erase-Record/Play Heads Use where it is difficult or impossible to install separate erase and R/P heads. For example, the equivalent of a three-head recorder can be achieved by use of the 6004 Combo record, and the 1201 playback head. .043-inch (1.1-mm) Track Width (2) .136-inch (3.45-mm) C-C Track Spacing	6002	5B	-	-	P-A2Q47K	ERP	25	400	2600	400	100	50	0.3	67	30	1.6	+4	10	32	12	60
	6003	5B	-	-	A2Q22K	ERP	25	800	5000	750	100	50	0.2	75	25	2.5	+4	13	1.8	100	5
	6004	5B	-	-	P-A2Q44R	ERP	25	50	350	100	500	50	0.7	28	60	-	-	10	32	12	60
	6005	5B	-	-	P-A2Q46K	ERP	25	200	1300	215	100	50	0.4	35	40	1.3	+3	10	32	12	60
	6006	5B	-	-	P-A2Q48R	ER	25	10	70	32	500	50	2	7.5	130	-	-	10	32	12	60
	6007	5B	-	-	P-A2Q48K	ERP	25	20	130	32	140	50	2.2	11	140	.3	+3	10	32	12	60
	6008	5B	-	-	P-A2Q125L	ERP	25	25	160	40	160	50	1.2	13	90	.5	+3	8.5	28	14	55
6009	5B	-	-	A2Q42N2	ERP	25	500	3300	770	200	50	0.2	45	20	2.5	0	10	32	12	60	
4-Track Mono Single Track Combo .043-inch (1.1-mm) Track Width	6026	6B	-	-	A1QC47K	ERP	25	400	2600	400	100	-	0.5	50	25	1.6	0	10	32	12	60
PREMIUM 2-Track Stereo COMBO Erase-Record/Play Head .080-inch (2.0-mm) Track Width (2) .160-inch (4.0-mm) C-C Track Spacing	6100	24B	-	-	P-A2H47K	ERP	25	400	2500	440	100	50	0.35	65	40	2.6	+5	10	27	22	70
	6101	24B	6151	58	P-A2H44R	ER	25	50	340	120	500	50	0.65	20	80	-	-	10	27	22	70
	(6152)*	24B	6152	58	P-A2H47K-R6*	ERP	8	400	2500	440	100	50	0.35	65	40	2.6	+50	10	27	22	70
	6103	24B	-	-	P-A2H44K	ERP	25	100	700	120	100	50	0.7	35	70	1.3	+3	10	27	22	70
	6104	24B	-	-	P-A2H48R	ER	25	10	75	30	500	50	2.0	10	170	-	-	10	27	22	70
2-Track Mono Combo Head .080-inch (2.0-mm) Track Width (1) Centered Track	6126	25B	-	58	P-A1HC44R	ER	25	50	320	70	500	-	0.9	25	75	-	-	10	27	22	70
	6127	25B	6177	58	A1HC47K-R6	ERP	8	400	2500	175	100	-	0.8	75	40	2.4	+1	10	27	22	70
	(6179)*	25B	6179	58	A1HC47R-R*	ER	25	180	1150	155	500	-	0.5	40	35	-	-	10	27	22	70
	6131	25B	-	-	A1HC15L2	ERP	25	390	2500	340	160	-	0.6	70	35	2.6	0	50	130	8	150
6183†	25B	6183	58	A1HC44R-R*	ER	25	50	350	70	500	-	1	20	80	-	-	10	27	22	70	
Mono Cassette Z-Combo E-RP .057-inch (1.45-mm) Track Width (1)	6200†	40W	-	-	ZW1R36F-A ¹	ERP	26	200	1300	280	50	-	- ¹	-	45	0.5	-12	2.2	36	30	25
2-Channel Cassette Z-Combo E-RP .057-inch (1.45-mm) Track Width (1)	6201†	41W	-	-	ZW2RK36F-A ¹	ERP	26	200	1300	280	50	45	- ¹	-	45	0.5	-12	2.2	36	30	25
Ext.-tip Z-Combo Super-8 Film .021-inch (.53-mm) Track Width (1)	6302	48W	-	-	XZ-W1LC47K ¹	ERP	28	400	2600	600	100	-	- ¹	-	30	0.7	-15	10	75	18	60
Mono F-cass Z-Combo, 1-inch Video .0135-inch (.34-mm) Track Width (1)	6303	-	-	-	H8001491VCZ	ERP	27	350	2400	705	100	-	- ¹	-	55	1.0	0	12	47	12	28
Ext.-tip Z-Combo E-RP .021-inch (.53-mm) Track Width (1)	6304	52B	-	-	XZ-R1LC96K ²	ERP	28	200	1300	465	100	-	- ²	-	30	0.5	-12	8	80	20	60
8-Track Stereo Z-Combo .021-inch (.53-mm) Track Width (2)	6800	35B	-	-	ZJ2L47K ²	ERP	26	450	3000	620	100	45	- ²	-	25	0.7	-12	14	45	11	50

¹Self-biased from erase section; 1.875 IPS, TP-18 Tape.
²Self-biased from erase section; 3.75 IPS, 3M-176 Tape.

Magnetic Head Specifications

PROFESSIONAL HEADS (Continued)	RCD MODEL NO., NO MOUNT ("D" indicates DURACORE) (H heads have mounts)	Outline Drawing & Case Size	OEM NORTRONICS Head No. (H heads have mounts) (LP indicates DURACORE)	Head Function	Application Notes	Inductance, 1 kHz mH	Impedance, 1 kHz ohms	Resistance, D.C. ohms	Gap Spacer uIn	Crosstalk Rejection 1 kHz dB	7.5 IPS unequalized R/P response using 3M206 tape pk-biased at 1 kHz, 12 dB below tape saturation.					NRZ digital write/read data, 7.5 IPS, 200 BPI		
											Peak Bias I 100 kHz rms mA	Peak Bias V. 100 kHz rms V	Audio Record Current rms uA	1 kHz Play Output rms mV	10 kHz/1 kHz Output Ratio dB	Write Current P.P. mA	Read Output 200 BPI P.P. mA	Max. Read Pack. Dens. BPI
"PRO" Series - Full Track Mono - Continued	9111	31B	PR-B1F6N	RP	2	200	1300	85	200	-	-	-	-	4.0	+3	5	75	800
	9111D		LPR-B1F6N	R	3	30	190	19	500	-	2.7	42	220	-	-	8	40	400
	9113	31B	PR-B1F14R	R	4	2	12	2.2	500	-	12.0	10	900	-	-	26	12	400
	9113D		LPR-B1F14R	P	6	5	25	8.6	50	-	-	-	-	0.3	+1	-	-	-
	9119	31B	PR-B1F7K	P	1	400	2500	195	100	-	-	-	-	4.7	+3	-	60	800
"PRO" Series 2-Track Stereo Format .082-inch (2.1-mm) Track Width .156-inch (3.95-mm) Track Spacing PRO Series play heads have low frequency response down to 25 Hz at 15 ips tape speed	9202	22B	PR-B2H12K	P	1	660	4100	395	100	50	-	-	-	3.5	+3	-	75	800
	9202D		LPR-B2H12K	R	4	10	70	22	500	50	3.0	15	250	-	-	10	12	400
	9203	22B	PR-B2H8R	R	4	10	70	22	500	50	3.0	15	250	-	-	10	12	400
	9203D		LPR-B2H8R	R	4	4.5	30	15	500	50	4.5	10	350	-	-	16	8	400
	9204	22B	PR-B2H11R	R	4	4.5	30	15	500	50	4.5	10	350	-	-	16	8	400
	9204D		LPR-B2H11R	R	3	50	330	95	500	50	0.9	35	130	-	-	4.5	26	400
	9205	22B	PR-B2H4R	R	3	50	330	95	500	50	0.9	35	130	-	-	4.5	26	400
	9205D		LPR-B2H4R	RP	5	10	65	15	100	50	7.0	22	400	0.4	0	25	12	1600
	9206	22B	PR-B2H9K	RP	2	200	1300	195	100	50	1.0	90	100	2.0	+2	3	36	1600
	9206D		LPR-B2H9K	RP	5	5	26	4.2	160	50	7.5	12	600	0.3	0	22	4.5	800
	9209	22B	PR-B2H5L	RP	5	5	26	4.2	160	50	7.5	12	600	0.3	0	22	4.5	800
	9209D		LPR-B2H5L	RP	5	20	130	20	100	50	5.0	30	330	0.5	+1	10	12	1600
	9210	22B	PR-B2H8K	RP	5	20	130	20	100	50	5.0	30	330	0.5	+1	10	12	1600
	9211	22B	PR-B2H4K	RP	2	100	640	95	100	50	1.5	75	150	1.3	+2	4.5	26	1600
	9211D		LPR-B2H4K	RP	2	400	2700	200	100	50	-	-	-	3.0	+2	2.5	50	1600
9213	22B	PR-B2H7K	P	1	400	2700	200	100	50	-	-	-	3.0	+2	2.5	50	1600	
9213D		LPR-B2H7K	R	4	2	16	10	500	50	12.0	13	800	-	-	22	5	400	
9214	22B	PR-B2H14R	R	4	2	16	10	500	50	12.0	13	800	-	-	22	5	400	
9214D		LPR-B2H14R																

STUDIO HEADS RECORD, PLAYBACK, AND RECORD/PLAY	1/2-INCH, 1-INCH 2-INCH TAPE	NORTRONICS RCD MODEL NO.	NORTRONICS OEM MODEL NO.	Head Function	Application Notes	Inductance 1 kHz mH	Impedance, 1 kHz Ohms	Resistance, D.C. Ohms	Gap Spacer uIn	Crosstalk Rejection 1 kHz dB	Average 15 ips Constant Current R/P characteristics using 3M206 tape peak biased at 1 kHz and recorded at 12 dB below tape saturation.					
											Peak Bias Current mA	Bias Volts RMS 100 kHz V	Record Current uA	Output RMS 1 kHz mV	10 kHz/1 kHz Ratio dB	
1/2-inch Tape, 3-Channel Format .100-inch (2.54-mm) Track Width, .185-inch (4.72-mm) Center-to-Center Track Spacing		9360	STP-3S9-E13	Play	44	600	5000	510	200	50	-	-	-	3.5	+6	
		9361	STR-3S5-E12	Record	44	4	30	8	500	50	9	9	400	-	-	
1/2-inch Tape, 4-Channel Format .070-inch (1.78-mm) Track Width .130-inch (3.30-mm) Center-to-Center Track Spacing		9460	STP-4B8-E3	Play	44	650	4200	650	200	50	-	-	-	3.7	+6	
		9461	STR-4BN7-E23	Record	44	4	30	14	500	50	6	9	375	-	-	
		9464	STP-4B8-F53	Play	45	650	4200	650	200	50	-	-	-	3.7	+6	
		9465	STR-4BN7-F64	Record	45	4	30	14	500	50	6	9	375	-	-	
		9469	STR-4BN31-E99	R/P	44	4	30	10	200	50	7	10	430	0.2	+6	
		9474	STP-4B31-F93	R/P	45	4	30	10	200	50	7	10	430	0.2	+6	
		9476	STP-4B32-E100	Play	44	100	650	150	100	50	-	-	-	1.3	+7	
1-inch Tape, 8-Channel Track Format .070-inch (1.78-mm) Track Width .130-inch (3.30-mm) Center-to-Center Track Spacing		9477	STP-4B46-N148	R/P	46	2	15	8	200	50	10	7	630	0.15	+6	
		9880	STP-8B8-E33	Play	44	650	4200	650	200	50	-	-	-	3.7	+6	
		9881	STR-8BN7-E5D	Record	44	4	30	14	500	50	6	9	375	-	-	
		9882	STR-8BN34-E112	Record	44	4	30	10	200	50	7	10	430	-	-	
		9885	STR-8BN53-G123	R/P	47	4	30	13	300	50	6	12	570	-	-	
		9886	STP-8B51-G124	Play	47	5	35	12	200	50	-	-	-	.55	+6	
		9887	9888+9892	R/P/E	48	-	-	-	-	-	-	-	-	-	-	-
2-inch Tape, 16-Channel Track Format .070-inch (1.78-mm) Track Width .127-inch (3.24-mm) Center-to-Center Track Spacing		9888	STRP-8BN11-N	Record	49	3	20	35	300	50	9	9	500	1.3	+5	
		9889	STP-8B35-E113	Play	44	50	350	275	300	50	-	-	-	-	-	
		9920	STR-16BN59-N143	Record	46	7	65	52	600	50	5	14	460	-	-	
1-inch Tape, 12-Channel Track Format .038-inch (.97-mm) Track Width .084-inch (2.14-mm) Center-to-Center Track Spacing		9921	STP-16BN60-N144	Play	46	70	500	100	100	50	-	-	-	1.8	+7	
		9980	STP-12UN21-E30	Play	44	650	4000	720	200	50	-	-	-	2.0	-	
2-inch Tape, 24-Channel Track Format .038-inch (.97-mm) Track Width .084-inch (2.14-mm) Center-to-Center Track Spacing		9981	STR-12UN20-E24	Record	44	6	40	35	500	50	6	10	300	-	-	
		9983	STR-24UN54-G130	R/P	47	4	30	15	300	50	6.5	10	380	0.4	+6	
		9984	STP-24UN52-G131	Play	47	5	35	15	200	50	-	-	-	0.4	+2	
		9988	STR-24UN61-N145	Record	46	7	50	26	400	50	5	12	440	-	-	
		9989	STP-24UN62-N146	Play	46	70	500	115	100	50	-	-	-	1.2	+7	
2-inch Tape, 16-Channel Track Format .070-inch (1.78-mm) Track Width .127-inch (3.24-mm) Center-to-Center Track Spacing		9990	STP-16B8-E27	Play	44	650	4200	650	200	50	-	-	-	3.7	+6	
		9992	STR-16BN7-E09	Record	44	4	30	14	500	50	6	9	375	-	-	
		9993	STR-16BN53-G127	R/P	47	4	30	10	200	50	7	10	430	-	-	
		9994	STP-16B51-G128	Play	47	5	35	12	200	50	-	-	-	.55	+6	
		9995	STRP-16BN11-N	Record	49	3	20	35	300	50	9	9	500	-	-	
		9996	STRP-16BN11-N	Play	49	50	350	275	300	50	-	-	-	-	1.3	+5
		9998	9995+9999	R/P/E	48	-	-	-	-	-	-	-	-	-	-	-

See data for 9995 and 9999 R/P and Erase Heads



Head Outlines

NOTE: DIMENSIONS ARE SHOWN IN INCHES OVER MILLIMETERS.

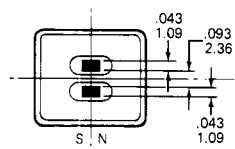
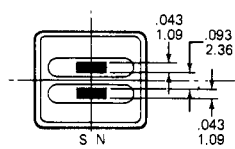
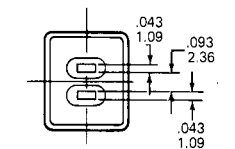
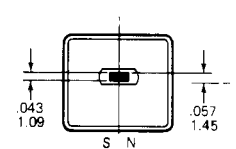
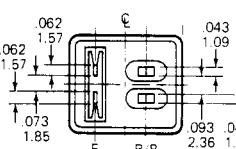
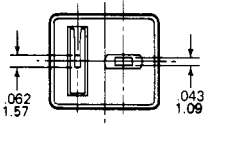
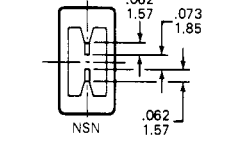
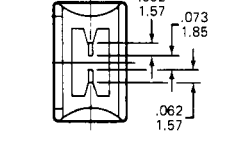
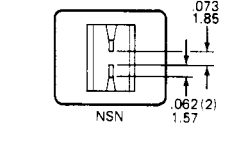
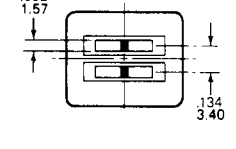
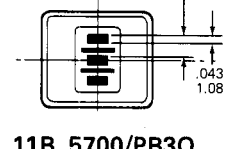
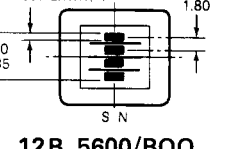
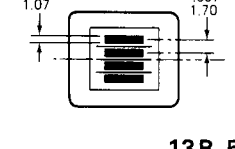
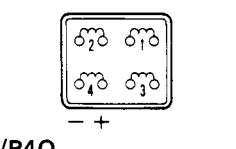
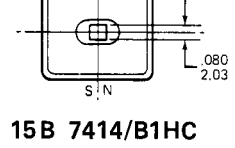
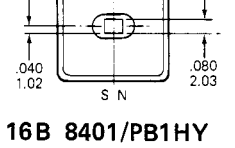
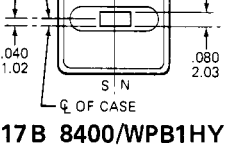
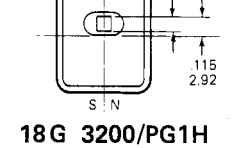
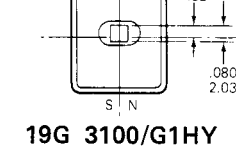
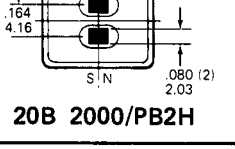
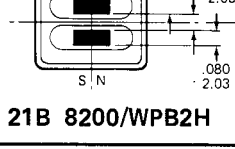
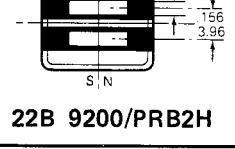
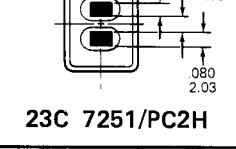
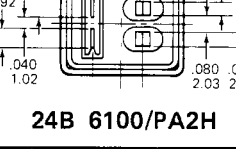
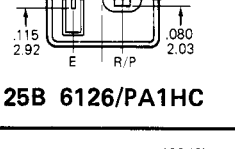
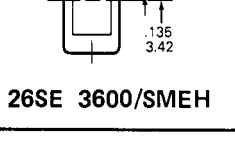
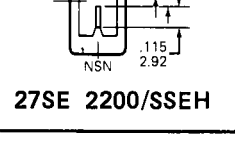
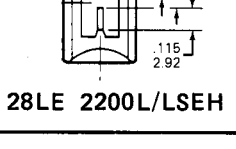
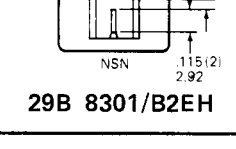
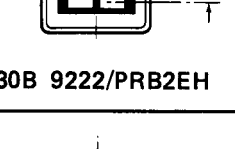
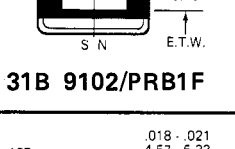
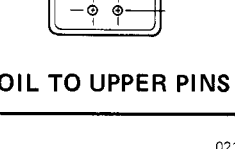
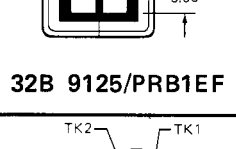
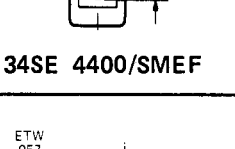
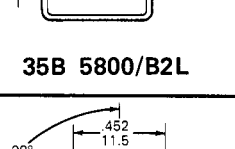
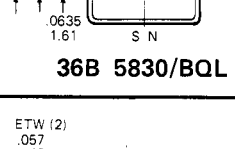
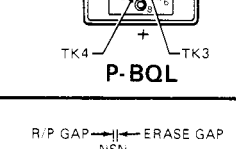
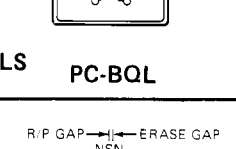
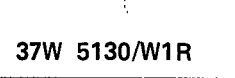
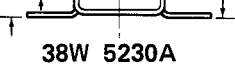
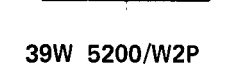
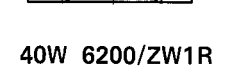
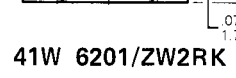
 <p>1B 1200/PB2Q</p>	 <p>2B 8600/WPB2Q</p>	 <p>3G 7608/PG2Q</p>	 <p>4B 7610/PB1QY</p>	 <p>5B 6000/PA2Q</p>
 <p>6B 6026/A1QC</p>	 <p>7SE 1400/SSEQ</p>	 <p>8LE 1400L/LSEQ</p>	 <p>9B 8701/B2EQ</p>	 <p>10B 8640/PRB2EQ</p>
<p>.100 TRACK SPACING 2.54 CENTER TO CENTER</p>  <p>11B 5700/PB3Q</p>	 <p>12B 5600/BQQ</p>	 <p>13B 5630/B4Q</p>	 <p>14B 8801/PCB4EQ</p>	
 <p>15B 7414/B1HC</p>	 <p>16B 8401/PB1HY</p>	 <p>17B 8400/WPB1HY</p>	 <p>18G 3200/PG1H</p>	 <p>19G 3100/G1HY</p>
 <p>20B 2000/PB2H</p>	 <p>21B 8200/WPB2H</p>	 <p>22B 9200/PRB2H</p>	 <p>23C 7251/PC2H</p>	 <p>24B 6100/PA2H</p>
 <p>25B 6126/PA1HC</p>	 <p>26SE 3600/SMEH</p>	 <p>27SE 2200/SSEH</p>	 <p>28LE 2200L/LSEH</p>	 <p>29B 8301/B2EH</p>
 <p>30B 9222/PRB2EH</p>	 <p>31B 9102/PRB1F</p>	<p>COIL TO UPPER PINS</p>  <p>32B 9125/PRB1EF</p>	 <p>33B 8101/B1EF</p>	
 <p>34SE 4400/SMEF</p>	 <p>35B 5800/B2L</p>	 <p>36B 5830/BQL</p>	 <p>37W 5130/W1R</p>	 <p>38W 5230A</p>
 <p>39W 5200/W2P</p>	 <p>40W 6200/ZW1R</p>	 <p>41W 6201/ZW2RK</p>	 <p>42W 6200/ZW1R</p>	 <p>43W 6201/ZW2RK</p>

F

Head Outlines

NOTE: DIMENSIONS ARE SHOWN IN INCHES OVER MILLIMETERS.

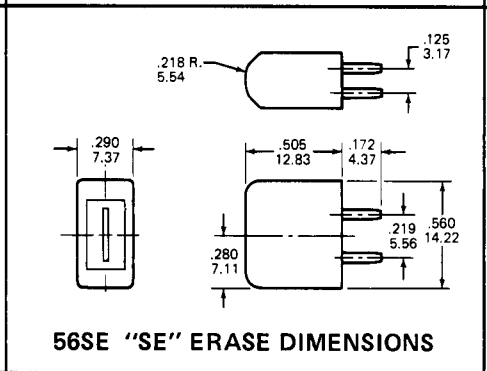
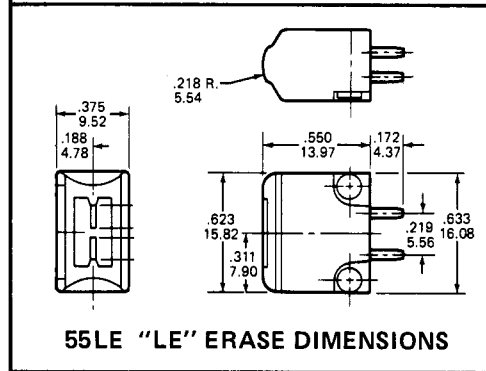
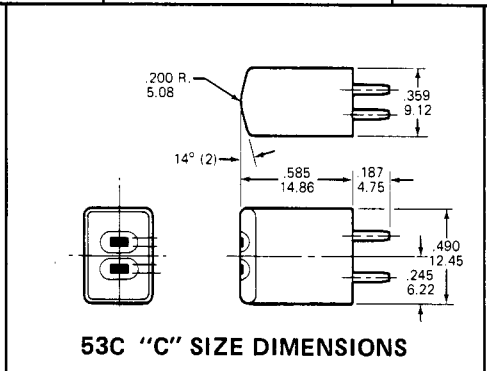
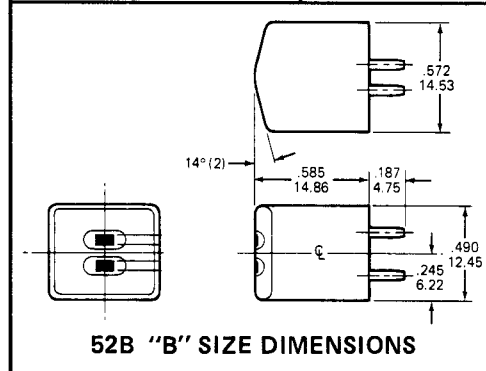
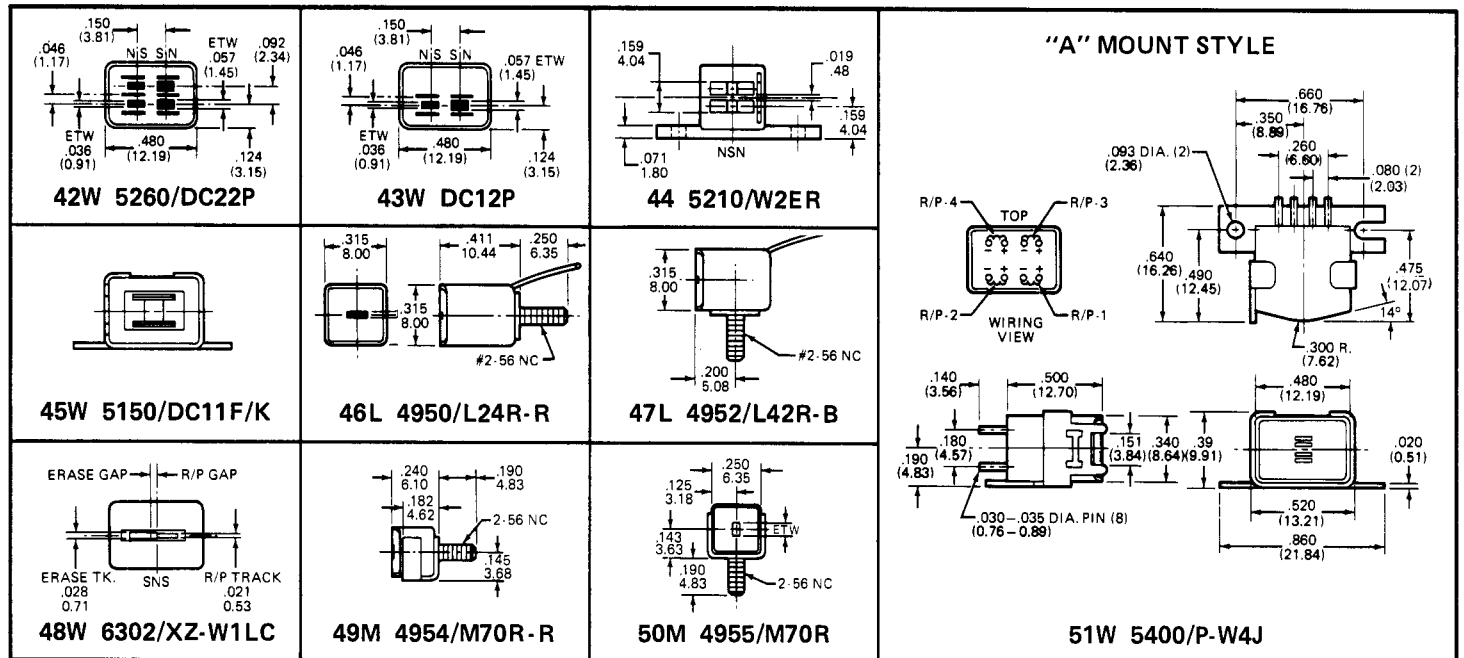

TYPICAL REAR MOUNT

1/4-28 NF
 .270 6.86 .062 1.57
 HEX NUT
 LOCK WASHER
 FLAT WASHER

1 RED-ORG 2 YEL-BLU Stereo Heads 1200/2000 etc. B2Q/B2H/SEH	ERASE R/P 1 BLK-WHT RED-ORG 2 BRN-GRN YEL-BLU COMBO 6100/A2H/A1HC (Mono Use #1)	1 BLK-RED 2 BRN-ORG 3 GRN-YEL 4 WHT-BLU 5600/5830 BQQ/BQL
---	--	--

REAR MOUNT LEADS - COLOR CODE

1 RED-ORG 2 YEL-BLU 3 WHT-BLK 5700/B3Q

58 REAR MOUNTS

SINGLE 6-32 STUD
 (.200 inch back from from head face, spot welded to spring clip.)
 QK-19 "SE" Erase Heads
 QK-21 "G" Size R/P Heads
 QK-66 All "B" Size Heads

59 BASE MOUNT QUIK-KITS

TWO 2-56 STUDS
 (On side of spring clip.)
 QK-18 "SE" Erase Heads
 QK-20 "G" Size R/P Heads
 QK-38 All "B" Size Heads

60 SIDE MOUNT QUIK-KITS

Nortronics Mounting Hardware and Accessories

Nortronics offers a variety of hardware and mounting accessories for use with replacement heads. These are available from nationwide Nortronics dealers as 'off the shelf' items and are detailed below:

BIAS OSCILLATOR TRANSFORMERS

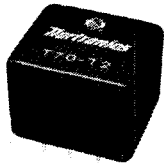

T-70 SERIES
for p.c. board mounting only

Cat. No. Description

- T70-T2 For Xsistor circuits, 50-120 KHz & 40, 80 or 120 Volts RMS.
- T70-T5 For Xsistor circuits, 150-200 KHz.
- T70-T6 For Xsistor circuits, 230-500 KHz & 70 Volts RMS.

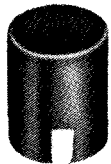

T-60 SERIES
for chassis mounting only

Cat. No. Description

- T60-T2 For Xsistor circuits, 60-110 KHz & 40, 80 or 120 Volts RMS.
- T60-T6 For Xsistor circuits, 230-500 KHz & 70 Volts RMS.
- T60-E For Vacuum Tube circuits, 40-70 KHz & 7 or 120 Volts RMS.
- T60-F For Vacuum Tube circuits, 60-100 KHz & 60 or 150 Volts RMS.

QUICK-KIT MOUNTING BRACKETS

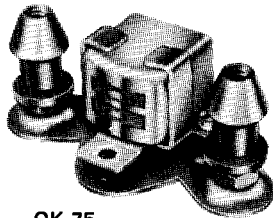

QK-75

QK-74 Universal Mounting Bracket. A unique, general-purpose assembly featuring alignment for head, face and azimuth. Two TG-7 guide posts may be added if desired, or tabs for guide posts may be snapped-off for limited space applications. Base features holes for mounting on recorder. For all Nortronics No-Mount Record, Play, Record/Play and Combo heads except 3000-3299 Series and miniature heads. Also fits special "B" Case Erase heads. Base size with tabs: 1 1/16" W x 1 27/32" L. Base size without tabs: 1 1/16" W x 1 7/32" L.

QK-75 Identical to QK-74, but two TG-7 guide posts are included.
QK-77 Identical to QK-74, but for No-Mt. heads in 3000-3299 Series.
QK-78 Identical to QK-74, but for No-Mount erase heads. Does not fit special "B" Case or "L" Case heads.

QK-76 Mounting hardware to convert many AMPEX nests to Nortronics heads. Includes mounting block with hardware and plug.

OTHER QUICK-KIT MOUNTS AVAILABLE

QK-18 Std. Erase - Side	QK-88 Magnecord 728	QK-112 810-042
QK-19 Std. Erase - Base	QK-89 Scully Adaptor	QK-113 810-043
QK-20 "G" Case - Side	QK-90 Scully Adaptor	QK-114 810-055 "B" Cart.
QK-21 "G" Case - Base	QK-91 Scully	QK-115 810-056
QK-35 "B" Case - Sp. Base	QK-92 Ampex 600	QK-116 Roberts
QK-38 "B" Case - Side	QK-93 Otari	QK-117 810-066
QK-66 "B" Case - Base	QK-94 Pioneer RT701	QK-119 Sony 300 R/P
QK-73 Electro Sound	QK-95 Pioneer 2022	QK-300 Pentron
QK-79 Ampex AG440	QK-101 Bell & Howell	QK-304 Concertone - Erase
QK-82 Tandberg	QK-102 "B" Dual-Stud Base	QK-305 Sony - Erase
QK-84 Concertone	QK-105 Bell & Howell	QK-306 Sony - Erase - Lge.
QK-85 Teac	QK-106 Concertone "B"	QK-701 Pioneer RT701 Oscillator
QK-86 Ampex 900/600	QK-110 810-045	
QK-87 Ampex PR-10	QK-111 810-046	

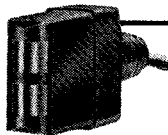

CONTACTOR HEAD

for end-of-tape sensing/track switching

- CH-3-N/B Contactor head, no mount head including base mount adapter
- CH3-R Contactor head, Rear/Mount
- WCH3-A Contactor head, cassette



TAPE GUIDE PLATE

TG-8 Stainless Steel for use with side-mount heads when space prohibits use of a TG-7 guide post or when replacing side-mount heads with a built-in tape guide. Can be used with L-5 or L-6 brackets. Slotted holes provide variable adjustment.
 Size: 21/32" H x 25/32" W.

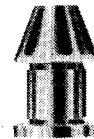

TAPE GUIDE POST

TG-7 Precision guide for positioning and controlling tape path travel. Special chrome-plated brass finish for longest life, minimum wear. Supplied with a variety of mounting hardware.

PLUG AND CABLE ASSEMBLIES

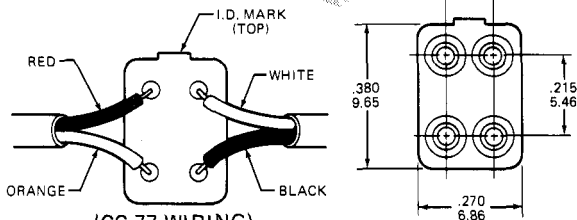
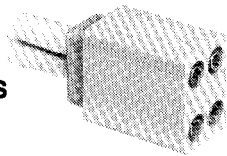

(CC-77 WIRING)

- CC-70 18" Plug and shielded insulated cable assembly for new model Nortronics heads (except Mono Combo and Cassette heads).
- CC-77 18" Plug and shielded insulated cable assembly for Nortronics Mono Combo and Cassette heads (except 5400 Series).
- CC-110 4" Plug and unshielded cable assembly for Mono heads.
- CC-111 4" Plug and unshielded cable assembly for Stereo heads.

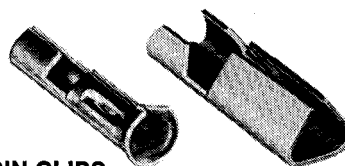

PIN CLIPS

- TC-54 Gold-plated beryllium copper (supplied in pkgs. of 100.) For heads with .050" pins.
- TC-91 Gold-plated beryllium copper (supplied in pkgs. of 100.) For heads with .030" pins.

PRESSURE PAD STRIPS

- PP-5 Pressure Pad Strips, 5/Pkg.
- PP-50 Pressure Pad Strips, 50/Pkg.

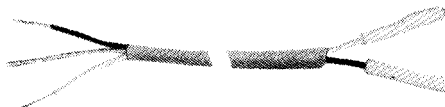

PIN CLIPS AND CABLE ASSEMBLIES

- CC-55 9" Terminal Clip and shielded cable assembly (red-orange) 2 per pkg. (for .050" pins only)
- CC-56 As above - coded (yellow-blue)
- CC-57 As above - coded (white-black)
- CC-58 As above - coded (red-black)
- CC-78 24" Terminal Clip and shielded cable assembly (red-orange) 2 per pkg. (for .050" pins only)
- CC-79 As above - coded (yellow-blue)
- CC-80 As above - coded (white-black)
- CC-81 As above - coded (red-black)

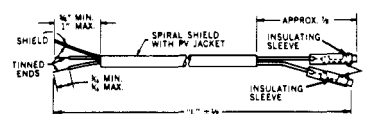

RECORDER CARE[™]
A DIVISION OF NORTRONICS®



Nortronics Company Inc., 8101 Tenth Avenue North, Minneapolis, Minnesota 55427 U.S.A. 612-545-0401 Telex 290304